

RCX-1000 USER

Intel® Xeon®/Core™ i7/i5/i3 Expandable Robust Computing System
Workstation-grade, Flexible, Fanless, Extended Temperature

Manual

Record of Revision

Version	Date	Page	Description	Remark
0.10	2019/03/26	All	Preliminary Release	
1.00	2019/04/17		Official Release	
1.10	2019/04/18	48, 49	Update	
2.00	2019/07/24	v, 1, 2, 3, 5, 7, 9, 11, 13, 15, 17, 19, 21, 23, 25, 27, 29, 31, 33, 35, 37, 39, 41, 43, 45	Update	
2.10	2019/12/13	All	Update	
2.20	2020/03/25	All	Update	
2.30	2021/03/11	3, 5, 7, 9, 11, 13, 15, 17, 19, 21, 23, 25, 27, 29, 31, 33, 35, 37, 39, 41, 43, 55	Update	
2.40	2021/12/30	48, 49	Update	
2.50	2022/06/14	48, 49, 152-154	Update	
2.60	2023/01/04	All	Update	

Disclaimer

This manual is released by Vecow Co., Ltd. for reference purpose only. All product offerings and specifications are subject to change without prior notice. Vecow Co., Ltd. is under no legal commitment to the details of this document. Vecow shall not be liable for direct, indirect, special, incidental, or consequential damages arising out of the use of this document, the products, or any third party infringements, which may result from such use.

Declaration of Conformity

FCC This equipment has been tested and found to comply with the limits for a Class A digital device, pursuant to part 15 of the FCC Rules. These limits are designed to provide reasonable protection against harmful interference when the equipment is operated in a commercial environment. This equipment generates, uses, and can radiate radio frequency energy, and if it is not installed and used in accordance with the instruction manual, it may cause harmful interference to radio communications. Operation of this equipment in a residential area is likely to cause harmful interference in which case the user will be required to correct the interference at his own expense.

CE The products described in this manual comply with all applicable European Union (CE) directives if it has a CE marking. For computer systems to remain CE compliant, only CE-compliant parts may be used. Maintaining CE compliance also requires proper cable and cabling techniques.

Copyright and Trademarks

This document contains proprietary information protected by copyright. No part of this publication may be reproduced in any form or by any means, electric, photocopying, recording or otherwise, without prior written authorization by Vecow Co., Ltd. The rights of all the brand names, product names, and trademarks belong to their respective owners.

Order Information

Part Number	Description
RCX-1430FR	RCX-1000, 2 GigE LAN, 4 Front-access SSD Tray, 1 PCIe x16, 1 PCIe x4, 1 PCIe x1, 4 COM, 6 USB 3.0, 2 SIM, 32 Isolated DIO
RCX-1430F	RCX-1000, 2 GigE LAN, 1 PCIe x16, 1 PCIe x4, 1 PCIe x1, 4 COM, 6 USB 3.0, 2 SIM, 32 Isolated DIO
RCX-1421FR	RCX-1000, 2 GigE LAN, 4 Front-access SSD Tray, 1 PCIe x16, 1 PCIe x4, 1 PCI, 4 COM, 6 USB 3.0, 2 SIM, 32 Isolated DIO
RCX-1421F	RCX-1000, 2 GigE LAN, 1 PCIe x16, 1 PCIe x4, 1 PCI, 4 COM, 6 USB 3.0, 2 SIM, 32 Isolated DIO
RCX-1412FR	RCX-1000, 2 GigE LAN, 4 Front-access SSD Tray, 1 PCIe x16, 2 PCI, 4 COM, 6 USB 3.0, 2 SIM, 32 Isolated DIO
RCX-1412F	RCX-1000, 2 GigE LAN, 1 PCIe x16, 2 PCI, 4 COM, 6 USB 3.0, 2 SIM, 32 Isolated DIO
RCX-1440R	RCX-1000, 2 GigE LAN, 4 Front-access SSD Tray, 1 PCIe x8, 3 PCIe x4, 4 COM, 6 USB 3.0, 2 SIM, 32 Isolated DIO
RCX-1440	RCX-1000, 2 GigE LAN, 1 PCIe x8, 3 PCIe x4, 4 COM, 6 USB 3.0, 2 SIM, 32 Isolated DIO
RCX-1422R	RCX-1000, 2 GigE LAN, 4 Front-access SSD Tray, 1 PCIe x8, 1 PCIe x4, 2 PCI, 4 COM, 6 USB 3.0, 2 SIM, 32 Isolated DIO
RCX-1422	RCX-1000, 2 GigE LAN, 1 PCIe x8, 1 PCIe x4, 2 PCI, 4 COM, 6 USB 3.0, 2 SIM, 32 Isolated DIO
RCX-1404R	RCX-1000, 2 GigE LAN, 4 Front-access SSD Tray, 4 PCI, 4 COM, 6 USB 3.0, 2 SIM, 32 Isolated DIO
RCX-1404	RCX-1000, 2 GigE LAN, 4 PCI, 4 COM, 6 USB 3.0, 2 SIM, 32 Isolated DIO
RCX-1220A	RCX-1000, 2 GigE LAN, 2 PCIe x8, 4COM, 6 USB 3.0, 2 SIM, 32 Isolated DIO
RCX-1220	RCX-1000, 2 GigE LAN, 1 PCIe x16, 1 PCIe x4, 4COM, 6 USB 3.0, 2 SIM, 32 Isolated DIO
RCX-1211	RCX-1000, 2 GigE LAN, 1 PCIe x16, 1 PCI, 4COM, 6 USB 3.0, 2 SIM, 32 Isolated DIO

CPU List

Series	CPU	Cores	GHz	TDP (W)	CPU	Cores	GHz	TDP (W)	ECC RAM
Intel® Xeon®	E-2176G	6	4.6	80	E-2278GE	8	4.7	80	Yes
					E-2278GEL	8	3.9	35	
	E-2124G	4	4.5	71	E-2226GE	6	4.6	80	
Intel® Core™	i7-8700	6	4.6	65	i7-9700E	8	4.4	65	N/A
	i7-8700T	6	4	35	i7-9700TE		3.8	35	
	i5-8500	6	4.1	65	i5-9500E	6	4.2	65	
	i5-8500T	6	3.5	35	i5-9500TE		3.6	35	
	i3-8100	4	3.6	65	i3-9100E	4	3.7	65	Yes
	i3-8100T	4	3.1	35	i3-9100TE		3.2	35	

Optional Accessories

Part Number	Description
DDR4 32G	Certified DDR4 32GB 2666MHz RAM
DDR4 16G	Certified DDR4 16GB 2666/2400/2133 MHz RAM
DDR4 8G	Certified DDR4 8GB 2666/2400/2133 MHz RAM
DDR4 4G	Certified DDR4 4GB 2666/2400/2133 MHz RAM
PWA-160WB-WT	160W, 24V, 85V AC to 264V AC Power Adaptor with 3-pin Terminal Block (7.62mm pitch), Wide Temperature -30°C to +70°C
PWA-280WB-WT	280W, 24V, 85V AC to 264V AC Power Adaptor with 3-pin Terminal Block (7.62mm pitch), Wide Temperature -30°C to +70°C
PWS-480W-WT	480W, 24V, 90V AC to 305V AC Power Supply, Wide-Temp, IP65
PWS-600W1	600W, 24V, 90V AC to 305V AC Power Supply
PWS-600W-WT	600W, 28.8V, 90V AC to 305V AC Power Supply, Wide Temperature -40°C to +70°C
FAN Module	Fan Module for RCX-1000 Series
FAN Sink	Fan Sink for RCX-1000 Series
PCIE HOLD-DOWN Kit	Hold Down Module for PCIe Card
TMK2-20P-100	Terminal Block 20-pin to Terminal Block 20-pin Cable, 100cm
TMK2-20P-500	Terminal Block 20-pin to Terminal Block 20-pin Cable, 500cm
TMB-TMBK-20P	Terminal Board with One 20-pin Terminal Block Connector and DIN-Rail Mounting
4G Module	Mini PCIe 4G/GPS Module with Antenna
WiFi & Bluetooth	WiFi & Bluetooth Module with Antenna

Table of Contents

CHAPTER 1	GENERAL INTRODUCTION	1
1.1	Overview	1
1.2	Features	2
1.3	Product Specification	3
1.3.1	Specifications of RCX-1430FR	3
1.3.2	Specifications of RCX-1430F	5
1.3.3	Specifications of RCX-1421FR	7
1.3.4	Specifications of RCX-1421F	9
1.3.5	Specifications of RCX-1412FR	11
1.3.6	Specifications of RCX-1412F	13
1.3.7	Specifications of RCX-1440R	15
1.3.8	Specifications of RCX-1440	17
1.3.9	Specifications of RCX-1422R	19
1.3.10	Specifications of RCX-1422	21
1.3.11	Specifications of RCX-1404R	23
1.3.12	Specifications of RCX-1404	25
1.3.13	Specifications of RCX-1220A	27
1.3.14	Specifications of RCX-1220	29
1.3.15	Specifications of RCX-1211	31
1.3.16	Specifications of RCX-1430FR PEG	33
1.3.17	Specifications of RCX-1430F PEG	35
1.3.18	Specifications of RCX-1421FR PEG	37
1.3.19	Specifications of RCX-1430F PEG	39
1.3.20	Specifications of RCX-1412FR PEG	41
1.3.21	Specifications of RCX-1412F PEG	43
1.4	Supported CPU List	45
1.5	Mechanical Dimension	45
1.5.1	Dimensions of RCX-1400FR/RCX-1000FR PEG	45
1.5.2	Dimensions of RCX-1400F/RCX-1000F PEG	46
1.5.3	Dimensions of RCX-1440R/RCX-1422R/RCX-1404R	46
1.5.4	Dimensions of RCX-1440/RCX-1422/RCX-1404	47
1.5.5	Dimensions of RCX-1220A/RCX-1220/RCX-1211	47

CHAPTER 2	GETTING TO KNOW YOUR RCX-1000	48
2.1	Packing List	48
2.2	Front Panel I/O Functions	50
2.3	Main Board Expansion Connectors	61
2.4	Main Board Jumper Settings	81
2.5	Ignition Control	85
CHAPTER 3	SYSTEM SETUP	88
3.1	How to open your RCX-1000	88
3.2	Installing CPU	89
3.3	Installing DDR4 SO-DIMM Modules	90
3.4	Installing Mini PCIe Card	91
3.5	Installing M.2 (Key E/Key M)	91
3.6	Installing Antenna Cable	92
3.7	Installing Sim Card	93
3.8	Installing PCI/PCIe Card	94
3.9	Installing SSD/HHD	96
3.10	Mounting Your RCX-1000	100
3.11	Cleaning the Air filter of RCX-1400FR/1400F	101
3.12	Installing the hold down bar for RCX-1400F/1400 Series	102
CHAPTER 4	BIOS SETUP	103
4.1	Entering BIOS Setup	103
4.2	Main	104
4.3	Advanced	104
4.4	Chipset	115
4.5	Security	121
4.6	Boot	123
4.7	Save & Exit	124

APPENDIX A : Isolated DIO Guide	125
APPENDIX B : Software Functions	130
APPENDIX C : RAID Functions	133
APPENDIX D : Power Consumption	139
APPENDIX E : Supported Memory & Storage List	144
APPENDIX F : How to Install Power Supply	148
APPENDIX G : Install Win11 (BIOS TPM Setting)	152

1

GENERAL INTRODUCTION

1.1 Overview

RCX-1000 is a high-performance, flexible and rugged computing engine for AIoT and Industry 4.0 applications. LGA1151 Socket supports 8-core 9th Generation Intel® Xeon®/Core™ i7/i5/i3 processor (Coffee Lake Refresh) running with workstation-grade Intel® C246 chipset; 4 SO-DIMM support dual channel DDR4 2666MHz up to 128GB ECC memory; advanced Intel® UHD Graphics 630 supporting DirectX 12, OpenGL 4.5 and OpenCL 2.0 API, multiple DVI, HDMI and DisplayPort display interfaces, up to Ultra HD 4K resolution; USB 3.1 Gen 2 (10Gbps), PCIe 3.0 (8GT/s), Multiple SATA III (6Gbps), USB 3.0 (5Gbps), and multiple wireless connections make seamless real-time high-speed data conveying possible; optimized power budget for optional independent graphics or any PCI/PCIe expansion functions. Vecow RCX-1000 Series Fanless Robust Computing System serves leading system performance, power productivity, and system-oriented integration for demanding workloads in real-time embedded applications.

Fanless -40°C to 75°C operating temperature, onboard multiple DVI, HDMI and DisplayPort display interfaces support triple independent displays, 2 GigE LAN ports support iAMT 12.0, 6 external USB 3.1 Gen 2 connections up to 10Gbps SuperSpeed data rate, 4 front-access 2.5" SSD/HDD trays with RAID 0, 1, 5, 10 data protection, multiple WiFi/4G/3G/LTE/GPRS/UMTS for seamless wireless data transfer, 4 COM RS-232/422/485, 2 M.2 expansions, 32 Isolated DIO, 6V to 36V wide range power input with 80V surge protection, configurable ignition power control, remote management functions, remote power switch, EN50155 and EN50121-3-2 compliant, 4 PCI/PCIe expansion slots with optimized power budget, flexible support NVIDIA® GeForce® RTX series graphics, Vecow RCX-1000 Series Fanless Robust Computing System features integrated functions for AI-oriented Computer Vision applications in harsh environment.

With leading performance, system-oriented integration, versatile configuration, smart manageability and industrial-grade reliability, Vecow RCX-1000 series expandable embedded workstation is your powerful solution for Machine Vision, Factory Automation, Robotic Control, Intelligent Surveillance, Machine Learning, Deep Learning, and any Artificial Intelligence (AI) edge computing applications in harsh environments.

1.2 Features

- 8 cores 9th generation Intel® Xeon®/Core™ i7/i5/i3 (Coffee Lake Refresh) processor with workstation-grade Intel® C246 chipset
- 4 DDR4 2666MHz memory, up to 128GB (ECC/Non-ECC)
- 6 ports external USB 3.1 Gen 2 support up to 10Gbps data transfer
- Rugged & Fanless design, -40°C to 75°C operating temperature
- Multiple DVI-I and DisplayPort display interface, up to 3 independent HD displays
- Powered by advanced NVIDIA Turing™ GPU architecture and all-new RTX platform, NVIDIA® GeForce RTX™ series graphics engine supports up to 6X the performance of previous generation graphics cards for real-time AI computing (RCX-1000 RTX Series only)
- 7 displays : 1 DVI, 1 HDMI, and 5 DisplayPort, up to 8K resolution (RCX-1000 RTX Series only)
- 2 independent GigE LAN, iAMT 12.0 supported
- 2 external SIM sockets for WiFi/4G/3G/LTE/GPRS/UMTS
- 4 front-access 2.5" SSD trays, RAID 0, 1, 5, 10 supported
- 3 PCI/PCIe slots, max 300W Power Budget for independent graphics operation
- 32 Isolated DIO, 4 COM RS-232/422/485
- 2 M.2 sockets : 1 M.2 Key M, 1 M.2 Key E
- 6V to 36V DC Power Input with 80V Surge Protection
- 24V to 36V DC Power Input with 80V Surge Protection (RCX-1000 RTX Series only)
- Configurable Ignition Power Control

1.3 Product Specification

1.3.1 Specifications of RCX-1430FR

System	
Processor	8 cores Intel®Xeon®/Core™ i7/i5/i3 Processor (Coffee Lake Refresh)
Chipset	Intel® C246 Chipset
BIOS	AMI
SIO	IT8786E
Memory	<ul style="list-style-type: none"> • DDR4 2666MHz (ECC/Non-ECC) • Up to 128GB • 4 260-pin SO-DIMM Socket
I/O Interface	
Serial	4 COM RS-232/422/485 (ESD 8KV)
USB	<ul style="list-style-type: none"> • 6 USB 3.1 Gen 2 (External) • 1 USB 2.0 (Internal)
Isolated DIO	32 Isolated DIO : 16 DI, 16 DO
LED	Power, HDD, Wireless
SIM Card	2 External SIM Card Socket
Expansion	
Mini PCIe	2 Full-size for PCIe/USB/External SIM Card/mSATA
PCI/PCIe	<ul style="list-style-type: none"> • 1 PCIe x16 Slot • 1 PCIe x4 Slot • 1 PCIe x1 Slot
M.2	1 M.2 Key E Socket
Graphics	
Graphics Processor	Intel® UHD Graphics 630
Interface	<ul style="list-style-type: none"> • 1 DVI-I : Up to 1920 x 1200 @ 60Hz • 1 DisplayPort : Up to 4096 x 2304 @60Hz • 1 Digital Display : Up to 1920x1080 @60Hz
Storage	
SATA	4 SATA III (6Gbps) support software RAID 0, 1, 5, 10
mSATA	2 SATA III (Mini PCIe Type, 6Gbps)
Storage Device	<ul style="list-style-type: none"> • 4 Front-access 2.5" SSD/HDD Tray • 1 M.2 Key M Socket
Audio	
Audio Codec	Realtek ALC888S-VD, 7.1 Channel HD Audio
Audio Interface	1 Mic-in, 1 Line-out
Ethernet	
LAN 1	Intel® I219LM Gigabit LAN supports iAMT 12.0

LAN 2	Intel® I210 Gigabit LAN
Power	
Input Voltage	6V to 36V, DC-in
Power Interface	3-pin Terminal Block : V+, V-, Frame Ground
Ignition Control	16 Mode (Internal)
Remote Switch	3-pin Terminal Block : On, Off, IGN
Surge Protection	Up to 80V/1ms Transient Power
Others	
TPM	Optional Infineon SLB9665 supports TPM 2.0, LPC interface
Watchdog Timer	Reset : 1 to 255 sec./min. per step
Smart Management	Wake on LAN, PXE supported
HW Monitor	Monitoring temperature, voltages. Auto throttling control when CPU overheats.
Software Support	
OS	Windows 10, Linux
Mechanical	
Dimension	330.0mm x 210.0mm x 172.0mm (12.99" x 8.27" x 6.77")
Weight	5.3 kg (11.7 lb)
Mounting	Wallmount by mounting bracket
Environment	
Operating Temperature	35W TDP CPU : -40°C to 75°C (-40°F to 167°F) 65W TDP CPU : -40°C to 55°C (-40°F to 131°F) 80W TDP CPU : -40°C to 45°C (-40°F to 113°F)
Storage Temperature	-40°C to 85°C (-40°F to 185°F)
Humidity	5% to 95% humidity, non-condensing
Relative Humidity	95% at 75°C
Shock	<ul style="list-style-type: none"> • IEC 60068-2-27 • SSD : 50G @wallmount, Half-sine, 11ms
Vibration	<ul style="list-style-type: none"> • IEC 60068-2-64 • SSD : 5Grms, 5Hz to 500Hz, 3 Axis
EMC	CE, FCC, EN50155, EN50121-3-2

1.3.2 Specifications of RCX-1430F

System	
Processor	8 cores Intel® Xeon®/Core™ i7/i5/i3 Processor (Coffee Lake Refresh)
Chipset	Intel® C246 Chipset
BIOS	AMI
SIO	IT8786E
Memory	<ul style="list-style-type: none"> • DDR4 2666MHz (ECC/Non-ECC) • Up to 128GB • 4 260-pin SO-DIMM Socket
I/O Interface	
Serial	4 COM RS-232/422/485 (ESD 8KV)
USB	<ul style="list-style-type: none"> • 6 USB 3.1 Gen 2 (External) • 1 USB 2.0 (Internal)
Isolated DIO	32 Isolated DIO : 16 DI, 16 DO
LED	Power, HDD, Wireless
SIM Card	2 External SIM Card Socket
Expansion	
Mini PCIe	2 Full-size for PCIe/USB/External SIM Card/mSATA
PCI/PCIe	<ul style="list-style-type: none"> • 1 PCIe x16 Slot • 1 PCIe x4 Slot • 1 PCIe x1 Slot
M.2	1 M.2 Key E Socket
Graphics	
Graphics Processor	Intel® UHD Graphics 630
Interface	<ul style="list-style-type: none"> • 1 DVI-I : Up to 1920 x 1200 @ 60Hz • 1 DisplayPort : Up to 4096 x 2304 @60Hz • 1 Digital Display : Up to 1920×1080 @60Hz
Storage	
SATA	4 SATA III (6Gbps) support software RAID 0, 1, 5, 10
mSATA	2 SATA III (Mini PCIe Type, 6Gbps)
Storage Device	<ul style="list-style-type: none"> • 4 2.5" SSD/HDD Bracket (Internal) • 1 M.2 Key M Socket
Audio	
Audio Codec	Realtek ALC888S-VD, 7.1 Channel HD Audio
Audio Interface	1 Mic-in, 1 Line-out
Ethernet	
LAN 1	Intel® I219LM Gigabit LAN supports iAMT 12.0

LAN 2	Intel® I210 Gigabit LAN
Power	
Input Voltage	6V to 36V, DC-in
Power Interface	3-pin Terminal Block : V+, V-, Frame Ground
Ignition Control	16 Mode (Internal)
Remote Switch	3-pin Terminal Block : On, Off, IGN
Surge Protection	Up to 80V/1ms Transient Power
Others	
TPM	Optional Infineon SLB9665 supports TPM 2.0, LPC interface
Watchdog Timer	Reset : 1 to 255 sec./min. per step
Smart Management	Wake on LAN, PXE supported
HW Monitor	Monitoring temperature, voltages. Auto throttling control when CPU overheats.
Software Support	
OS	Windows 10, Linux
Mechanical	
Dimension	330.0mm x 210.0mm x 172.0mm (12.99" x 8.27" x 6.77")
Weight	4.9 kg (10.8 lb)
Mounting	Wallmount by mounting bracket
Environment	
Operating Temperature	35W TDP CPU : -40°C to 75°C (-40°F to 167°F) 65W TDP CPU : -40°C to 55°C (-40°F to 131°F) 80W TDP CPU : -40°C to 45°C (-40°F to 113°F)
Storage Temperature	-40°C to 85°C (-40°F to 185°F)
Humidity	5% to 95% humidity, non-condensing
Relative Humidity	95% at 75°C
Shock	<ul style="list-style-type: none"> • IEC 60068-2-27 • SSD : 50G @wallmount, Half-sine, 11ms
Vibration	<ul style="list-style-type: none"> • IEC 60068-2-64 • SSD : 5Grms, 5Hz to 500Hz, 3 Axis
EMC	CE, FCC, EN50155, EN50121-3-2

1.3.3 Specifications of RCX-1421FR

System	
Processor	8 cores Intel® Xeon®/Core™ i7/i5/i3 Processor (Coffee Lake Refresh)
Chipset	Intel® C246 Chipset
BIOS	AMI
SIO	IT8786E
Memory	<ul style="list-style-type: none"> • DDR4 2666MHz (ECC/Non-ECC) • Up to 128GB • 4 260-pin SO-DIMM Socket
I/O Interface	
Serial	4 COM RS-232/422/485 (ESD 8KV)
USB	<ul style="list-style-type: none"> • 6 USB 3.1 Gen 2 (External) • 1 USB 2.0 (Internal)
Isolated DIO	32 Isolated DIO : 16 DI, 16 DO
LED	Power, HDD, Wireless
SIM Card	2 External SIM Card Socket
Expansion	
Mini PCIe	2 Full-size for PCIe/USB/External SIM Card/mSATA
PCI/PCIe	<ul style="list-style-type: none"> • 1 PCIe x16 Slot • 1 PCIe x4 Slot • 1 PCI Slot
M.2	1 M.2 Key E Socket
Graphics	
Graphics Processor	Intel® UHD Graphics 630
Interface	<ul style="list-style-type: none"> • 1 DVI-I : Up to 1920 x 1200 @ 60Hz • 1 DisplayPort : Up to 4096 x 2304 @60Hz • 1 Digital Display : Up to 1920×1080 @60Hz
Storage	
SATA	4 SATA III (6Gbps) support software RAID 0, 1, 5, 10
mSATA	2 SATA III (Mini PCIe Type, 6Gbps)
Storage Device	<ul style="list-style-type: none"> • 4 Front-access 2.5" SSD/HDD Tray • 1 M.2 Key M Socket
Audio	
Audio Codec	Realtek ALC888S-VD, 7.1 Channel HD Audio
Audio Interface	1 Mic-in, 1 Line-out
Ethernet	
LAN 1	Intel® I219LM Gigabit LAN supports iAMT 12.0

LAN 2	Intel® I210 Gigabit LAN
Power	
Input Voltage	6V to 36V, DC-in
Power Interface	3-pin Terminal Block : V+, V-, Frame Ground
Ignition Control	16 Mode (Internal)
Remote Switch	3-pin Terminal Block : On, Off, IGN
Surge Protection	Up to 80V/1ms Transient Power
Others	
TPM	Optional Infineon SLB9665 supports TPM 2.0, LPC interface
Watchdog Timer	Reset : 1 to 255 sec./min. per step
Smart Management	Wake on LAN, PXE supported
HW Monitor	Monitoring temperature, voltages. Auto throttling control when CPU overheats.
Software Support	
OS	Windows 10, Linux
Mechanical	
Dimension	330.0mm x 210.0mm x 172.0mm (12.99" x 8.27" x 6.77")
Weight	5.3 kg (11.7 lb)
Mounting	Wallmount by mounting bracket
Environment	
Operating Temperature	35W TDP CPU : -40°C to 75°C (-40°F to 167°F) 65W TDP CPU : -40°C to 55°C (-40°F to 131°F) 80W TDP CPU : -40°C to 45°C (-40°F to 113°F)
Storage Temperature	-40°C to 85°C (-40°F to 185°F)
Humidity	5% to 95% humidity, non-condensing
Relative Humidity	95% at 75°C
Shock	<ul style="list-style-type: none"> • IEC 60068-2-27 • SSD : 50G @wallmount, Half-sine, 11ms
Vibration	<ul style="list-style-type: none"> • IEC 60068-2-64 • SSD : 5Grms, 5Hz to 500Hz, 3 Axis
EMC	CE, FCC, EN50155, EN50121-3-2

1.3.4 Specifications of RCX-1421F

System	
Processor	8 cores Intel® Xeon®/Core™ i7/i5/i3 Processor (Coffee Lake Refresh)
Chipset	Intel® C246 Chipset
BIOS	AMI
SIO	IT8786E
Memory	<ul style="list-style-type: none"> • DDR4 2666MHz (ECC/Non-ECC) • Up to 128GB • 4 260-pin SO-DIMM Socket
I/O Interface	
Serial	4 COM RS-232/422/485 (ESD 8KV)
USB	<ul style="list-style-type: none"> • 6 USB 3.1 Gen 2 (External) • 1 USB 2.0 (Internal)
Isolated DIO	32 Isolated DIO : 16 DI, 16 DO
LED	Power, HDD, Wireless
SIM Card	2 External SIM Card Socket
Expansion	
Mini PCIe	2 Full-size for PCIe/USB/External SIM Card/mSATA
PCI/PCIe	<ul style="list-style-type: none"> • 1 PCIe x16 Slot • 1 PCIe x4 Slot • 1 PCI Slot
M.2	1 M.2 Key E Socket
Graphics	
Graphics Processor	Intel® UHD Graphics 630
Interface	<ul style="list-style-type: none"> • 1 DVI-I : Up to 1920 x 1200 @ 60Hz • 1 DisplayPort : Up to 4096 x 2304 @60Hz • 1 Digital Display : Up to 1920×1080 @60Hz
Storage	
SATA	4 SATA III (6Gbps) support software RAID 0, 1, 5, 10
mSATA	2 SATA III (Mini PCIe Type, 6Gbps)
Storage Device	<ul style="list-style-type: none"> • 4 2.5" SSD/HDD Bracket (Internal) • 1 M.2 Key M Socket
Audio	
Audio Codec	Realtek ALC888S-VD, 7.1 Channel HD Audio
Audio Interface	1 Mic-in, 1 Line-out
Ethernet	
LAN 1	Intel® I219LM Gigabit LAN supports iAMT 12.0

LAN 2	Intel® I210 Gigabit LAN
Power	
Input Voltage	6V to 36V, DC-in
Power Interface	3-pin Terminal Block : V+, V-, Frame Ground
Ignition Control	16 Mode (Internal)
Remote Switch	3-pin Terminal Block : On, Off, IGN
Surge Protection	Up to 80V/1ms Transient Power
Others	
TPM	Optional Infineon SLB9665 supports TPM 2.0, LPC interface
Watchdog Timer	Reset : 1 to 255 sec./min. per step
Smart Management	Wake on LAN, PXE supported
HW Monitor	Monitoring temperature, voltages. Auto throttling control when CPU overheats.
Software Support	
OS	Windows 10, Linux
Mechanical	
Dimension	330.0mm x 210.0mm x 172.0mm (12.99" x 8.27" x 6.77")
Weight	4.9 kg (10.8 lb)
Mounting	Wallmount by mounting bracket
Environment	
Operating Temperature	35W TDP CPU : -40°C to 75°C (-40°F to 167°F) 65W TDP CPU : -40°C to 55°C (-40°F to 131°F) 80W TDP CPU : -40°C to 45°C (-40°F to 113°F)
Storage Temperature	-40°C to 85°C (-40°F to 185°F)
Humidity	5% to 95% humidity, non-condensing
Relative Humidity	95% at 75°C
Shock	<ul style="list-style-type: none"> • IEC 60068-2-27 • SSD : 50G @wallmount, Half-sine, 11ms
Vibration	<ul style="list-style-type: none"> • IEC 60068-2-64 • SSD : 5Grms, 5Hz to 500Hz, 3 Axis
EMC	CE, FCC, EN50155, EN50121-3-2

1.3.5 Specifications of RCX-1412FR

System	
Processor	8 cores Intel® Xeon®/Core™ i7/i5/i3 Processor (Coffee Lake Refresh)
Chipset	Intel® C246 Chipset
BIOS	AMI
SIO	IT8786E
Memory	<ul style="list-style-type: none"> • DDR4 2666MHz (ECC/Non-ECC) • Up to 128GB • 4 260-pin SO-DIMM Socket
I/O Interface	
Serial	4 COM RS-232/422/485 (ESD 8KV)
USB	<ul style="list-style-type: none"> • 6 USB 3.1 Gen 2 (External) • 1 USB 2.0 (Internal)
Isolated DIO	32 Isolated DIO : 16 DI, 16 DO
LED	Power, HDD, Wireless
SIM Card	2 External SIM Card Socket
Expansion	
Mini PCIe	2 Full-size for PCIe/USB/External SIM Card/mSATA
PCI/PCIe	<ul style="list-style-type: none"> • 1 PCIe x16 Slot • 2 PCI Slot
M.2	1 M.2 Key E Socket
Graphics	
Graphics Processor	Intel® UHD Graphics 630
Interface	<ul style="list-style-type: none"> • 1 DVI-I : Up to 1920 x 1200 @ 60Hz • 1 DisplayPort : Up to 4096 x 2304 @60Hz • 1 Digital Display : Up to 1920×1080 @60Hz
Storage	
SATA	4 SATA III (6Gbps) support software RAID 0, 1, 5, 10
mSATA	2 SATA III (Mini PCIe Type, 6Gbps)
Storage Device	<ul style="list-style-type: none"> • 4 Front-access 2.5" SSD/HDD Tray • 1 M.2 Key M Socket
Audio	
Audio Codec	Realtek ALC888S-VD, 7.1 Channel HD Audio
Audio Interface	1 Mic-in, 1 Line-out
Ethernet	
LAN 1	Intel® I219LM Gigabit LAN supports iAMT 12.0

LAN 2	Intel® I210 Gigabit LAN
Power	
Input Voltage	6V to 36V, DC-in
Power Interface	3-pin Terminal Block : V+, V-, Frame Ground
Ignition Control	16 Mode (Internal)
Remote Switch	3-pin Terminal Block : On, Off, IGN
Surge Protection	Up to 80V/1ms Transient Power
Others	
TPM	Optional Infineon SLB9665 supports TPM 2.0, LPC interface
Watchdog Timer	Reset : 1 to 255 sec./min. per step
Smart Management	Wake on LAN, PXE supported
HW Monitor	Monitoring temperature, voltages. Auto throttling control when CPU overheats.
Software Support	
OS	Windows 10, Linux
Mechanical	
Dimension	330.0mm x 210.0mm x 172.0mm (12.99" x 8.27" x 6.77")
Weight	5.3 kg (11.7 lb)
Mounting	Wallmount by mounting bracket
Environment	
Operating Temperature	35W TDP CPU : -40°C to 75°C (-40°F to 167°F) 65W TDP CPU : -40°C to 55°C (-40°F to 131°F) 80W TDP CPU : -40°C to 45°C (-40°F to 113°F)
Storage Temperature	-40°C to 85°C (-40°F to 185°F)
Humidity	5% to 95% humidity, non-condensing
Relative Humidity	95% at 75°C
Shock	<ul style="list-style-type: none"> • IEC 60068-2-27 • SSD : 50G @wallmount, Half-sine, 11ms
Vibration	<ul style="list-style-type: none"> • IEC 60068-2-64 • SSD : 5Grms, 5Hz to 500Hz, 3 Axis
EMC	CE, FCC, EN50155, EN50121-3-2

1.3.6 Specifications of RCX-1412F

System	
Processor	8 cores Intel® Xeon®/Core™ i7/i5/i3 Processor (Coffee Lake Refresh)
Chipset	Intel® C246 Chipset
BIOS	AMI
SIO	IT8786E
Memory	<ul style="list-style-type: none"> • DDR4 2666MHz (ECC/Non-ECC) • Up to 128GB • 4 260-pin SO-DIMM Socket
I/O Interface	
Serial	4 COM RS-232/422/485 (ESD 8KV)
USB	<ul style="list-style-type: none"> • 6 USB 3.1 Gen 2 (External) • 1 USB 2.0 (Internal)
Isolated DIO	32 Isolated DIO : 16 DI, 16 DO
LED	Power, HDD, Wireless
SIM Card	2 External SIM Card Socket
Expansion	
Mini PCIe	2 Full-size for PCIe/USB/External SIM Card/mSATA
PCI/PCIe	<ul style="list-style-type: none"> • 1 PCIe x16 Slot • 2 PCI Slot
M.2	1 M.2 Key E Socket
Graphics	
Graphics Processor	Intel® UHD Graphics 630
Interface	<ul style="list-style-type: none"> • 1 DVI-I : Up to 1920 x 1200 @ 60Hz • 1 DisplayPort : Up to 4096 x 2304 @60Hz • 1 Digital Display : Up to 1920×1080 @60Hz
Storage	
SATA	4 SATA III (6Gbps) support software RAID 0, 1, 5, 10
mSATA	2 SATA III (Mini PCIe Type, 6Gbps)
Storage Device	<ul style="list-style-type: none"> • 4 2.5" SSD/HDD Bracket (Internal) • 1 M.2 Key M Socket
Audio	
Audio Codec	Realtek ALC888S-VD, 7.1 Channel HD Audio
Audio Interface	1 Mic-in, 1 Line-out
Ethernet	
LAN 1	Intel® I219LM Gigabit LAN supports iAMT 12.0

LAN 2	Intel® I210 Gigabit LAN
Power	
Input Voltage	6V to 36V, DC-in
Power Interface	3-pin Terminal Block : V+, V-, Frame Ground
Ignition Control	16 Mode (Internal)
Remote Switch	3-pin Terminal Block : On, Off, IGN
Surge Protection	Up to 80V/1ms Transient Power
Others	
TPM	Optional Infineon SLB9665 supports TPM 2.0, LPC interface
Watchdog Timer	Reset : 1 to 255 sec./min. per step
Smart Management	Wake on LAN, PXE supported
HW Monitor	Monitoring temperature, voltages. Auto throttling control when CPU overheats.
Software Support	
OS	Windows 10, Linux
Mechanical	
Dimension	330.0mm x 210.0mm x 172.0mm (12.99" x 8.27" x 6.77")
Weight	4.9 kg (10.8 lb)
Mounting	Wallmount by mounting bracket
Environment	
Operating Temperature	35W TDP CPU : -40°C to 75°C (-40°F to 167°F) 65W TDP CPU : -40°C to 55°C (-40°F to 131°F) 80W TDP CPU : -40°C to 45°C (-40°F to 113°F)
Storage Temperature	-40°C to 85°C (-40°F to 185°F)
Humidity	5% to 95% humidity, non-condensing
Relative Humidity	95% at 75°C
Shock	<ul style="list-style-type: none"> • IEC 60068-2-27 • SSD : 50G @wallmount, Half-sine, 11ms
Vibration	<ul style="list-style-type: none"> • IEC 60068-2-64 • SSD : 5Grms, 5Hz to 500Hz, 3 Axis
EMC	CE, FCC, EN50155, EN50121-3-2

1.3.7 Specifications of RCX-1440R

System	
Processor	8 cores Intel® Xeon®/Core™ i7/i5/i3 Processor (Coffee Lake Refresh)
Chipset	Intel® C246 Chipset
BIOS	AMI
SIO	IT8786E
Memory	<ul style="list-style-type: none"> • DDR4 2666MHz (ECC/Non-ECC) • Up to 128GB • 4 260-pin SO-DIMM Socket
I/O Interface	
Serial	4 COM RS-232/422/485 (ESD 8KV)
USB	<ul style="list-style-type: none"> • 6 USB 3.1 Gen 2 (External) • 1 USB 2.0 (Internal)
Isolated DIO	32 Isolated DIO : 16 DI, 16 DO
LED	Power, HDD, Wireless
SIM Card	2 External SIM Card Socket
Expansion	
Mini PCIe	2 Full-size for PCIe/USB/External SIM Card/mSATA
PCI/PCIe	<ul style="list-style-type: none"> • 1 PCIe x8 Slot • 3 PCIe x4 Slot
M.2	1 M.2 Key E Socket
Graphics	
Graphics Processor	Intel® UHD Graphics 630
Interface	<ul style="list-style-type: none"> • 1 DVI-I : Up to 1920 x 1200 @ 60Hz • 1 DisplayPort : Up to 4096 x 2304 @60Hz • 1 Digital Display : Up to 1920×1080 @60Hz
Storage	
SATA	4 SATA III (6Gbps) support software RAID 0, 1, 5, 10
mSATA	2 SATA III (Mini PCIe Type, 6Gbps)
Storage Device	<ul style="list-style-type: none"> • 4 Front-access 2.5" SSD/HDD Tray • 1 M.2 Key M Socket
Audio	
Audio Codec	Realtek ALC888S-VD, 7.1 Channel HD Audio
Audio Interface	1 Mic-in, 1 Line-out
Ethernet	
LAN 1	Intel® I219LM Gigabit LAN supports iAMT 12.0

LAN 2	Intel® I210 Gigabit LAN
Power	
Input Voltage	6V to 36V, DC-in
Power Interface	3-pin Terminal Block : V+, V-, Frame Ground
Ignition Control	16 Mode (Internal)
Remote Switch	3-pin Terminal Block : On, Off, IGN
Surge Protection	Up to 80V/1ms Transient Power
Others	
TPM	Optional Infineon SLB9665 supports TPM 2.0, LPC interface
Watchdog Timer	Reset : 1 to 255 sec./min. per step
Smart Management	Wake on LAN, PXE supported
HW Monitor	Monitoring temperature, voltages. Auto throttling control when CPU overheats.
Software Support	
OS	Windows 10, Linux
Mechanical	
Dimension	250.4mm x 210.0mm x 172.0mm (9.86" x 8.27" x 6.77")
Weight	5.0 kg (11 lb)
Mounting	Wallmount by mounting bracket
Environment	
Operating Temperature	35W TDP CPU : -40°C to 75°C (-40°F to 167°F) 65W TDP CPU : -40°C to 55°C (-40°F to 131°F) 80W TDP CPU : -40°C to 45°C (-40°F to 113°F)
Storage Temperature	-40°C to 85°C (-40°F to 185°F)
Humidity	5% to 95% humidity, non-condensing
Relative Humidity	95% at 75°C
Shock	<ul style="list-style-type: none"> • IEC 60068-2-27 • SSD : 50G @wallmount, Half-sine, 11ms
Vibration	<ul style="list-style-type: none"> • IEC 60068-2-64 • SSD : 5Grms, 5Hz to 500Hz, 3 Axis
EMC	CE, FCC, EN50155, EN50121-3-2

1.3.8 Specifications of RCX-1440

System	
Processor	8 cores Intel® Xeon®/Core™ i7/i5/i3 Processor (Coffee Lake Refresh)
Chipset	Intel® C246 Chipset
BIOS	AMI
SIO	IT8786E
Memory	<ul style="list-style-type: none"> • DDR4 2666MHz (ECC/Non-ECC) • Up to 128GB • 4 260-pin SO-DIMM Socket
I/O Interface	
Serial	4 COM RS-232/422/485 (ESD 8KV)
USB	<ul style="list-style-type: none"> • 6 USB 3.1 Gen 2 (External) • 1 USB 2.0 (Internal)
Isolated DIO	32 Isolated DIO : 16 DI, 16 DO
LED	Power, HDD, Wireless
SIM Card	2 External SIM Card Socket
Expansion	
Mini PCIe	2 Full-size for PCIe/USB/External SIM Card/mSATA
PCI/PCIe	<ul style="list-style-type: none"> • 1 PCIe x8 Slot • 3 PCIe x4 Slot
M.2	1 M.2 Key E Socket
Graphics	
Graphics Processor	Intel® UHD Graphics 630
Interface	<ul style="list-style-type: none"> • 1 DVI-I : Up to 1920 x 1200 @ 60Hz • 1 DisplayPort : Up to 4096 x 2304 @60Hz • 1 Digital Display : Up to 1920×1080 @60Hz
Storage	
SATA	4 SATA III (6Gbps) support software RAID 0, 1, 5, 10
mSATA	2 SATA III (Mini PCIe Type, 6Gbps)
Storage Device	<ul style="list-style-type: none"> • 4 2.5" SSD/HDD Bracket (Internal) • 1 M.2 Key M Socket
Audio	
Audio Codec	Realtek ALC888S-VD, 7.1 Channel HD Audio
Audio Interface	1 Mic-in, 1 Line-out
Ethernet	
LAN 1	Intel® I219LM Gigabit LAN supports iAMT 12.0

LAN 2	Intel® I210 Gigabit LAN
Power	
Input Voltage	6V to 36V, DC-in
Power Interface	3-pin Terminal Block : V+, V-, Frame Ground
Ignition Control	16 Mode (Internal)
Remote Switch	3-pin Terminal Block : On, Off, IGN
Surge Protection	Up to 80V/1ms Transient Power
Others	
TPM	Optional Infineon SLB9665 supports TPM 2.0, LPC interface
Watchdog Timer	Reset : 1 to 255 sec./min. per step
Smart Management	Wake on LAN, PXE supported
HW Monitor	Monitoring temperature, voltages. Auto throttling control when CPU overheats.
Software Support	
OS	Windows 10, Linux
Mechanical	
Dimension	250.4mm x 210.0mm x 172.0mm (9.86" x 8.27" x 6.77")
Weight	4.6 kg (10.1 b)
Mounting	Wallmount by mounting bracket
Environment	
Operating Temperature	35W TDP CPU : -40°C to 75°C (-40°F to 167°F) 65W TDP CPU : -40°C to 55°C (-40°F to 131°F) 80W TDP CPU : -40°C to 45°C (-40°F to 113°F)
Storage Temperature	-40°C to 85°C (-40°F to 185°F)
Humidity	5% to 95% humidity, non-condensing
Relative Humidity	95% at 75°C
Shock	<ul style="list-style-type: none"> • IEC 60068-2-27 • SSD : 50G @wallmount, Half-sine, 11ms
Vibration	<ul style="list-style-type: none"> • IEC 60068-2-64 • SSD : 5Grms, 5Hz to 500Hz, 3 Axis
EMC	CE, FCC, EN50155, EN50121-3-2

1.3.9 Specifications of RCX-1422R

System	
Processor	8 cores Intel® Xeon®/Core™ i7/i5/i3 Processor (Coffee Lake Refresh)
Chipset	Intel® C246 Chipset
BIOS	AMI
SIO	IT8786E
Memory	<ul style="list-style-type: none"> • DDR4 2666MHz (ECC/Non-ECC) • Up to 128GB • 4 260-pin SO-DIMM Socket
I/O Interface	
Serial	4 COM RS-232/422/485 (ESD 8KV)
USB	<ul style="list-style-type: none"> • 6 USB 3.1 Gen 2 (External) • 1 USB 2.0 (Internal)
Isolated DIO	32 Isolated DIO : 16 DI, 16 DO
LED	Power, HDD, Wireless
SIM Card	2 External SIM Card Socket
Expansion	
Mini PCIe	2 Full-size for PCIe/USB/External SIM Card/mSATA
PCI/PCIe	<ul style="list-style-type: none"> • 1 PCIe x16 Slot • 1 PCIe x4 Slot • 2 PCI Slot
M.2	1 M.2 Key E Socket
Graphics	
Graphics Processor	Intel® UHD Graphics 630
Interface	<ul style="list-style-type: none"> • 1 DVI-I : Up to 1920 x 1200 @ 60Hz • 1 DisplayPort : Up to 4096 x 2304 @60Hz • 1 Digital Display : Up to 1920×1080 @60Hz
Storage	
SATA	4 SATA III (6Gbps) support software RAID 0, 1, 5, 10
mSATA	2 SATA III (Mini PCIe Type, 6Gbps)
Storage Device	<ul style="list-style-type: none"> • 4 Front-access 2.5" SSD/HDD Tray • 1 M.2 Key M Socket
Audio	
Audio Codec	Realtek ALC888S-VD, 7.1 Channel HD Audio
Audio Interface	1 Mic-in, 1 Line-out
Ethernet	
LAN 1	Intel® I219LM Gigabit LAN supports iAMT 12.0

LAN 2	Intel® I210 Gigabit LAN
Power	
Input Voltage	6V to 36V, DC-in
Power Interface	3-pin Terminal Block : V+, V-, Frame Ground
Ignition Control	16 Mode (Internal)
Remote Switch	3-pin Terminal Block : On, Off, IGN
Surge Protection	Up to 80V/1ms Transient Power
Others	
TPM	Optional Infineon SLB9665 supports TPM 2.0, LPC interface
Watchdog Timer	Reset : 1 to 255 sec./min. per step
Smart Management	Wake on LAN, PXE supported
HW Monitor	Monitoring temperature, voltages. Auto throttling control when CPU overheats.
Software Support	
OS	Windows 10, Linux
Mechanical	
Dimension	250.4mm x 210.0mm x 172.0mm (9.86" x 8.27" x 6.77")
Weight	5.0 kg (11 lb)
Mounting	Wallmount by mounting bracket
Environment	
Operating Temperature	35W TDP CPU : -40°C to 75°C (-40°F to 167°F) 65W TDP CPU : -40°C to 55°C (-40°F to 131°F) 80W TDP CPU : -40°C to 45°C (-40°F to 113°F)
Storage Temperature	-40°C to 85°C (-40°F to 185°F)
Humidity	5% to 95% humidity, non-condensing
Relative Humidity	95% at 75°C
Shock	<ul style="list-style-type: none"> IEC 60068-2-27 SSD : 50G @wallmount, Half-sine, 11ms
Vibration	<ul style="list-style-type: none"> IEC 60068-2-64 SSD : 5Grms, 5Hz to 500Hz, 3 Axis
EMC	CE, FCC, EN50155, EN50121-3-2

1.3.10 Specifications of RCX-1422

System	
Processor	8 cores Intel® Xeon®/Core™ i7/i5/i3 Processor (Coffee Lake Refresh)
Chipset	Intel® C246 Chipset
BIOS	AMI
SIO	IT8786E
Memory	<ul style="list-style-type: none"> • DDR4 2666MHz (ECC/Non-ECC) • Up to 128GB • 4 260-pin SO-DIMM Socket
I/O Interface	
Serial	4 COM RS-232/422/485 (ESD 8KV)
USB	<ul style="list-style-type: none"> • 6 USB 3.1 Gen 2 (External) • 1 USB 2.0 (Internal)
Isolated DIO	32 Isolated DIO : 16 DI, 16 DO
LED	Power, HDD, Wireless
SIM Card	2 External SIM Card Socket
Expansion	
Mini PCIe	2 Full-size for PCIe/USB/External SIM Card/mSATA
PCI/PCIe	<ul style="list-style-type: none"> • 1 PCIe x16 Slot • 1 PCIe x4 Slot • 2 PCI Slot
M.2	1 M.2 Key E Socket
Graphics	
Graphics Processor	Intel® UHD Graphics 630
Interface	<ul style="list-style-type: none"> • 1 DVI-I : Up to 1920 x 1200 @ 60Hz • 1 DisplayPort : Up to 4096 x 2304 @60Hz • 1 Digital Display : Up to 1920x1080 @60Hz
Storage	
SATA	4 SATA III (6Gbps) support software RAID 0, 1, 5, 10
mSATA	2 SATA III (Mini PCIe Type, 6Gbps)
Storage Device	<ul style="list-style-type: none"> • 4 2.5" SSD/HDD Bracket (Internal) • 1 M.2 Key M Socket
Audio	
Audio Codec	Realtek ALC888S-VD, 7.1 Channel HD Audio
Audio Interface	1 Mic-in, 1 Line-out
Ethernet	
LAN 1	Intel® I219LM Gigabit LAN supports iAMT 12.0

LAN 2	Intel® I210 Gigabit LAN
Power	
Input Voltage	6V to 36V, DC-in
Power Interface	3-pin Terminal Block : V+, V-, Frame Ground
Ignition Control	16 Mode (Internal)
Remote Switch	3-pin Terminal Block : On, Off, IGN
Surge Protection	Up to 80V/1ms Transient Power
Others	
TPM	Optional Infineon SLB9665 supports TPM 2.0, LPC interface
Watchdog Timer	Reset : 1 to 255 sec./min. per step
Smart Management	Wake on LAN, PXE supported
HW Monitor	Monitoring temperature, voltages. Auto throttling control when CPU overheats.
Software Support	
OS	Windows 10, Linux
Mechanical	
Dimension	250.4mm x 210.0mm x 172.0mm (9.86" x 8.27" x 6.77")
Weight	4.6 kg (10.1 b)
Mounting	Wallmount by mounting bracket
Environment	
Operating Temperature	35W TDP CPU : -40°C to 75°C (-40°F to 167°F) 65W TDP CPU : -40°C to 55°C (-40°F to 131°F) 80W TDP CPU : -40°C to 45°C (-40°F to 113°F)
Storage Temperature	-40°C to 85°C (-40°F to 185°F)
Humidity	5% to 95% humidity, non-condensing
Relative Humidity	95% at 75°C
Shock	<ul style="list-style-type: none"> • IEC 60068-2-27 • SSD : 50G @wallmount, Half-sine, 11ms
Vibration	<ul style="list-style-type: none"> • IEC 60068-2-64 • SSD : 5Grms, 5Hz to 500Hz, 3 Axis
EMC	CE, FCC, EN50155, EN50121-3-2

1.3.11 Specifications of RCX-1404R

System	
Processor	8 cores Intel®Xeon®/Core™ i7/i5/i3 Processor (Coffee Lake Refresh)
Chipset	Intel® C246 Chipset
BIOS	AMI
SIO	IT8786E
Memory	<ul style="list-style-type: none"> • DDR4 2666MHz (ECC/Non-ECC) • Up to 128GB • 4 260-pin SO-DIMM Socket
I/O Interface	
Serial	4 COM RS-232/422/485 (ESD 8KV)
USB	<ul style="list-style-type: none"> • 6 USB 3.1 Gen 2 (External) • 1 USB 2.0 (Internal)
Isolated DIO	32 Isolated DIO : 16 DI, 16 DO
LED	Power, HDD, Wireless
SIM Card	2 External SIM Card Socket
Expansion	
Mini PCIe	2 Full-size for PCIe/USB/External SIM Card/mSATA
PCI/PCIe	4 PCI Slot
M.2	1 M.2 Key E Socket
Graphics	
Graphics Processor	Intel® UHD Graphics 630
Interface	<ul style="list-style-type: none"> • 1 DVI-I : Up to 1920 x 1200 @ 60Hz • 1 DisplayPort : Up to 4096 x 2304 @60Hz • 1 Digital Display : Up to 1920x1080 @60Hz
Storage	
SATA	4 SATA III (6Gbps) support software RAID 0, 1, 5, 10
mSATA	2 SATA III (Mini PCIe Type, 6Gbps)
Storage Device	<ul style="list-style-type: none"> • 4 Front-access 2.5" SSD/HDD Tray • 1 M.2 Key M Socket
Audio	
Audio Codec	Realtek ALC888S-VD, 7.1 Channel HD Audio
Audio Interface	1 Mic-in, 1 Line-out
Ethernet	
LAN 1	Intel® I219LM Gigabit LAN supports iAMT 12.0

LAN 2	Intel® I210 Gigabit LAN
Power	
Input Voltage	6V to 36V, DC-in
Power Interface	3-pin Terminal Block : V+, V-, Frame Ground
Ignition Control	16 Mode (Internal)
Remote Switch	3-pin Terminal Block : On, Off, IGN
Surge Protection	Up to 80V/1ms Transient Power
Others	
TPM	Optional Infineon SLB9665 supports TPM 2.0, LPC interface
Watchdog Timer	Reset : 1 to 255 sec./min. per step
Smart Management	Wake on LAN, PXE supported
HW Monitor	Monitoring temperature, voltages. Auto throttling control when CPU overheats.
Software Support	
OS	Windows 10, Linux
Mechanical	
Dimension	250.4mm x 210.0mm x 172.0mm (9.86" x 8.27" x 6.77")
Weight	5.0 kg (11 lb)
Mounting	Wallmount by mounting bracket
Environment	
Operating Temperature	35W TDP CPU : -40°C to 75°C (-40°F to 167°F) 65W TDP CPU : -40°C to 55°C (-40°F to 131°F) 80W TDP CPU : -40°C to 45°C (-40°F to 113°F)
Storage Temperature	-40°C to 85°C (-40°F to 185°F)
Humidity	5% to 95% humidity, non-condensing
Relative Humidity	95% at 75°C
Shock	<ul style="list-style-type: none"> • IEC 60068-2-27 • SSD : 50G @wallmount, Half-sine, 11ms
Vibration	<ul style="list-style-type: none"> • IEC 60068-2-64 • SSD : 5Grms, 5Hz to 500Hz, 3 Axis
EMC	CE, FCC, EN50155, EN50121-3-2

1.3.12 Specifications of RCX-1404

System	
Processor	8 cores Intel®Xeon®/Core™ i7/i5/i3 Processor (Coffee Lake Refresh)
Chipset	Intel® C246 Chipset
BIOS	AMI
SIO	IT8786E
Memory	<ul style="list-style-type: none"> • DDR4 2666MHz (ECC/Non-ECC) • Up to 128GB • 4 260-pin SO-DIMM Socket
I/O Interface	
Serial	4 COM RS-232/422/485 (ESD 8KV)
USB	<ul style="list-style-type: none"> • 6 USB 3.1 Gen 2 (External) • 1 USB 2.0 (Internal)
Isolated DIO	32 Isolated DIO : 16 DI, 16 DO
LED	Power, HDD, Wireless
SIM Card	2 External SIM Card Socket
Expansion	
Mini PCIe	2 Full-size for PCIe/USB/External SIM Card/mSATA
PCI/PCIe	4 PCI Slot
M.2	1 M.2 Key E Socket
Graphics	
Graphics Processor	Intel® UHD Graphics 630
Interface	<ul style="list-style-type: none"> • 1 DVI-I : Up to 1920 x 1200 @ 60Hz • 1 DisplayPort : Up to 4096 x 2304 @60Hz • 1 Digital Display : Up to 1920x1080 @60Hz
Storage	
SATA	4 SATA III (6Gbps) support software RAID 0, 1, 5, 10
mSATA	2 SATA III (Mini PCIe Type, 6Gbps)
Storage Device	<ul style="list-style-type: none"> • 4 2.5" SSD/HDD Bracket (Internal) • 1 M.2 Key M Socket
Audio	
Audio Codec	Realtek ALC888S-VD, 7.1 Channel HD Audio
Audio Interface	1 Mic-in, 1 Line-out
Ethernet	
LAN 1	Intel® I219LM Gigabit LAN supports iAMT 12.0

LAN 2	Intel® I210 Gigabit LAN
Power	
Input Voltage	6V to 36V, DC-in
Power Interface	3-pin Terminal Block : V+, V-, Frame Ground
Ignition Control	16 Mode (Internal)
Remote Switch	3-pin Terminal Block : On, Off, IGN
Surge Protection	Up to 80V/1ms Transient Power
Others	
TPM	Optional Infineon SLB9665 supports TPM 2.0, LPC interface
Watchdog Timer	Reset : 1 to 255 sec./min. per step
Smart Management	Wake on LAN, PXE supported
HW Monitor	Monitoring temperature, voltages. Auto throttling control when CPU overheats.
Software Support	
OS	Windows 10, Linux
Mechanical	
Dimension	250.4mm x 210.0mm x 172.0mm (9.86" x 8.27" x 6.77")
Weight	4.6 kg (10.1 b)
Mounting	Wallmount by mounting bracket
Environment	
Operating Temperature	35W TDP CPU : -40°C to 75°C (-40°F to 167°F) 65W TDP CPU : -40°C to 55°C (-40°F to 131°F) 80W TDP CPU : -40°C to 45°C (-40°F to 113°F)
Storage Temperature	-40°C to 85°C (-40°F to 185°F)
Humidity	5% to 95% humidity, non-condensing
Relative Humidity	95% at 75°C
Shock	<ul style="list-style-type: none"> • IEC 60068-2-27 • SSD : 50G @wallmount, Half-sine, 11ms
Vibration	<ul style="list-style-type: none"> • IEC 60068-2-64 • SSD : 5Grms, 5Hz to 500Hz, 3 Axis
EMC	CE, FCC, EN50155, EN50121-3-2

1.3.13 Specifications of RCX-1220A

System	
Processor	8 cores Intel®Xeon®/Core™ i7/i5/i3 Processor (Coffee Lake Refresh)
Chipset	Intel® C246 Chipset
BIOS	AMI
SIO	IT8786E
Memory	<ul style="list-style-type: none"> • DDR4 2666MHz (ECC/Non-ECC) • Up to 128GB • 4 260-pin SO-DIMM Socket
I/O Interface	
Serial	4 COM RS-232/422/485 (ESD 8KV)
USB	<ul style="list-style-type: none"> • 6 USB 3.1 Gen 2 (External) • 1 USB 2.0 (Internal)
Isolated DIO	32 Isolated DIO : 16 DI, 16 DO
LED	Power, HDD, Wireless
SIM Card	2 External SIM Card Socket
Expansion	
Mini PCIe	2 Full-size for PCIe/USB/External SIM Card/mSATA
PCI/PCIe	2 PCIe x8 Slot
M.2	1 M.2 Key E Socket
Graphics	
Graphics Processor	Intel® UHD Graphics 630
Interface	<ul style="list-style-type: none"> • 1 DVI-I : Up to 1920 x 1200 @ 60Hz • 1 DisplayPort : Up to 4096 x 2304 @60Hz • 1 Digital Display : Up to 1920x1080 @60Hz
Storage	
SATA	4 SATA III (6Gbps) support software RAID 0, 1, 5, 10
mSATA	2 SATA III (Mini PCIe Type, 6Gbps)
Storage Device	<ul style="list-style-type: none"> • 4 2.5" SSD/HDD Bracket (Internal) • 1 M.2 Key M Socket
Audio	
Audio Codec	Realtek ALC888S-VD, 7.1 Channel HD Audio
Audio Interface	1 Mic-in, 1 Line-out
Ethernet	
LAN 1	Intel® I219LM Gigabit LAN supports iAMT 12.0

LAN 2	Intel® I210 Gigabit LAN
Power	
Input Voltage	6V to 36V, DC-in
Power Interface	3-pin Terminal Block : V+, V-, Frame Ground
Ignition Control	16 Mode (Internal)
Remote Switch	3-pin Terminal Block : On, Off, IGN
Surge Protection	Up to 80V/1ms Transient Power
Others	
TPM	Optional Infineon SLB9665 supports TPM 2.0, LPC interface
Watchdog Timer	Reset : 1 to 255 sec./min. per step
Smart Management	Wake on LAN, PXE supported
HW Monitor	Monitoring temperature, voltages. Auto throttling control when CPU overheats.
Software Support	
OS	Windows 10, Linux
Mechanical	
Dimension	250.4mm x 210.0mm x 131.4mm (9.86" x 8.27" x 5.17")
Weight	4.3 kg (9.5 lb)
Mounting	Wallmount by mounting bracket
Environment	
Operating Temperature	35W TDP CPU : -40°C to 75°C (-40°F to 167°F) 65W TDP CPU : -40°C to 55°C (-40°F to 131°F) 80W TDP CPU : -40°C to 45°C (-40°F to 113°F)
Storage Temperature	-40°C to 85°C (-40°F to 185°F)
Humidity	5% to 95% humidity, non-condensing
Relative Humidity	95% at 75°C
Shock	<ul style="list-style-type: none"> • IEC 60068-2-27 • SSD : 50G @wallmount, Half-sine, 11ms
Vibration	<ul style="list-style-type: none"> • IEC 60068-2-64 • SSD : 5Grms, 5Hz to 500Hz, 3 Axis
EMC	CE, FCC, EN50155, EN50121-3-2

1.3.14 Specifications of RCX-1220

System	
Processor	8 cores Intel® Xeon®/Core™ i7/i5/i3 Processor (Coffee Lake Refresh)
Chipset	Intel® C246 Chipset
BIOS	AMI
SIO	IT8786E
Memory	<ul style="list-style-type: none"> • DDR4 2666MHz (ECC/Non-ECC) • Up to 128GB • 4 260-pin SO-DIMM Socket
I/O Interface	
Serial	4 COM RS-232/422/485 (ESD 8KV)
USB	<ul style="list-style-type: none"> • 6 USB 3.1 Gen 2 (External) • 1 USB 2.0 (Internal)
Isolated DIO	32 Isolated DIO : 16 DI, 16 DO
LED	Power, HDD, Wireless
SIM Card	2 External SIM Card Socket
Expansion	
Mini PCIe	2 Full-size for PCIe/USB/External SIM Card/mSATA
PCI/PCIe	<ul style="list-style-type: none"> • 1 PCIe x16 Slot • 1 PCIe x4 Slot
M.2	1 M.2 Key E Socket
Graphics	
Graphics Processor	Intel® UHD Graphics 630
Interface	<ul style="list-style-type: none"> • 1 DVI-I : Up to 1920 x 1200 @ 60Hz • 1 DisplayPort : Up to 4096 x 2304 @60Hz • 1 Digital Display : Up to 1920×1080 @60Hz
Storage	
SATA	4 SATA III (6Gbps) support software RAID 0, 1, 5, 10
mSATA	2 SATA III (Mini PCIe Type, 6Gbps)
Storage Device	<ul style="list-style-type: none"> • 4 2.5" SSD/HDD Bracket (Internal) • 1 M.2 Key M Socket
Audio	
Audio Codec	Realtek ALC888S-VD, 7.1 Channel HD Audio
Audio Interface	1 Mic-in, 1 Line-out
Ethernet	
LAN 1	Intel® I219LM Gigabit LAN supports iAMT 12.0

LAN 2	Intel® I210 Gigabit LAN
Power	
Input Voltage	6V to 36V, DC-in
Power Interface	3-pin Terminal Block : V+, V-, Frame Ground
Ignition Control	16 Mode (Internal)
Remote Switch	3-pin Terminal Block : On, Off, IGN
Surge Protection	Up to 80V/1ms Transient Power
Others	
TPM	Optional Infineon SLB9665 supports TPM 2.0, LPC interface
Watchdog Timer	Reset : 1 to 255 sec./min. per step
Smart Management	Wake on LAN, PXE supported
HW Monitor	Monitoring temperature, voltages. Auto throttling control when CPU overheats.
Software Support	
OS	Windows 10, Linux
Mechanical	
Dimension	250.4mm x 210.0mm x 131.4mm (9.86" x 8.27" x 5.17")
Weight	4.3 kg (9.5 lb)
Mounting	Wallmount by mounting bracket
Environment	
Operating Temperature	35W TDP CPU : -40°C to 75°C (-40°F to 167°F) 65W TDP CPU : -40°C to 55°C (-40°F to 131°F) 80W TDP CPU : -40°C to 45°C (-40°F to 113°F)
Storage Temperature	-40°C to 85°C (-40°F to 185°F)
Humidity	5% to 95% humidity, non-condensing
Relative Humidity	95% at 75°C
Shock	<ul style="list-style-type: none"> • IEC 60068-2-27 • SSD : 50G @wallmount, Half-sine, 11ms
Vibration	<ul style="list-style-type: none"> • IEC 60068-2-64 • SSD : 5Grms, 5Hz to 500Hz, 3 Axis
EMC	CE, FCC, EN50155, EN50121-3-2

1.3.15 Specifications of RCX-1211

System	
Processor	8 cores Intel® Xeon®/Core™ i7/i5/i3 Processor (Coffee Lake Refresh)
Chipset	Intel® C246 Chipset
BIOS	AMI
SIO	IT8786E
Memory	<ul style="list-style-type: none"> • DDR4 2666MHz (ECC/Non-ECC) • Up to 128GB • 4 260-pin SO-DIMM Socket
I/O Interface	
Serial	4 COM RS-232/422/485 (ESD 8KV)
USB	<ul style="list-style-type: none"> • 6 USB 3.1 Gen 2 (External) • 1 USB 2.0 (Internal)
Isolated DIO	32 Isolated DIO : 16 DI, 16 DO
LED	Power, HDD, Wireless
SIM Card	2 External SIM Card Socket
Expansion	
Mini PCIe	2 Full-size for PCIe/USB/External SIM Card/mSATA
PCI/PCIe	<ul style="list-style-type: none"> • 1 PCIe x16 Slot • 1 PCI Slot
M.2	1 M.2 Key E Socket
Graphics	
Graphics Processor	Intel® UHD Graphics 630
Interface	<ul style="list-style-type: none"> • 1 DVI-I : Up to 1920 x 1200 @ 60Hz • 1 DisplayPort : Up to 4096 x 2304 @60Hz • 1 Digital Display : Up to 1920×1080 @60Hz
Storage	
SATA	4 SATA III (6Gbps) support software RAID 0, 1, 5, 10
mSATA	2 SATA III (Mini PCIe Type, 6Gbps)
Storage Device	<ul style="list-style-type: none"> • 4 2.5" SSD/HDD Bracket (Internal) • 1 M.2 Key M Socket
Audio	
Audio Codec	Realtek ALC888S-VD, 7.1 Channel HD Audio
Audio Interface	1 Mic-in, 1 Line-out
Ethernet	
LAN 1	Intel® I219LM Gigabit LAN supports iAMT 12.0

LAN 2	Intel® I210 Gigabit LAN
Power	
Input Voltage	6V to 36V, DC-in
Power Interface	3-pin Terminal Block : V+, V-, Frame Ground
Ignition Control	16 Mode (Internal)
Remote Switch	3-pin Terminal Block : On, Off, IGN
Surge Protection	Up to 80V/1ms Transient Power
Others	
TPM	Optional Infineon SLB9665 supports TPM 2.0, LPC interface
Watchdog Timer	Reset : 1 to 255 sec./min. per step
Smart Management	Wake on LAN, PXE supported
HW Monitor	Monitoring temperature, voltages. Auto throttling control when CPU overheats.
Software Support	
OS	Windows 10, Linux
Mechanical	
Dimension	250.4mm x 210.0mm x 131.4mm (9.86" x 8.27" x 5.17")
Weight	4.3 kg (9.5 lb)
Mounting	Wallmount by mounting bracket
Environment	
Operating Temperature	35W TDP CPU : -40°C to 75°C (-40°F to 167°F) 65W TDP CPU : -40°C to 55°C (-40°F to 131°F) 80W TDP CPU : -40°C to 45°C (-40°F to 113°F)
Storage Temperature	-40°C to 85°C (-40°F to 185°F)
Humidity	5% to 95% humidity, non-condensing
Relative Humidity	95% at 75°C
Shock	<ul style="list-style-type: none"> • IEC 60068-2-27 • SSD : 50G @wallmount, Half-sine, 11ms
Vibration	<ul style="list-style-type: none"> • IEC 60068-2-64 • SSD : 5Grms, 5Hz to 500Hz, 3 Axis
EMC	CE, FCC, EN50155, EN50121-3-2

1.3.16 Specifications of RCX-1430FR PEG

System	
Processor	8 cores Intel® Xeon®/Core™ i7/i5/i3 Processor (Coffee Lake Refresh)
Chipset	Intel® C246 Chipset
BIOS	AMI
SIO	IT8786E
Memory	<ul style="list-style-type: none"> • DDR4 2666MHz (ECC/Non-ECC) • Up to 128GB • 4 260-pin SO-DIMM Socket
I/O Interface	
Serial	4 COM RS-232/422/485 (ESD 8KV)
USB	<ul style="list-style-type: none"> • 6 USB 3.1 Gen 2 (External) • 1 USB 2.0 (Internal)
Isolated DIO	32 Isolated DIO : 16 DI, 16 DO
LED	Power, HDD, Wireless
SIM Card	2 External SIM Card Socket
Expansion	
Mini PCIe	2 Full-size for PCIe/USB/External SIM Card/mSATA
PCI/PCIe	<ul style="list-style-type: none"> • 1 PCIe x16 Slot • 1 PCIe x16 Slot with x4 signal • 1 PCIe x16 Slot with x1 signal
M.2	1 M.2 Key E Socket
Graphics	
Graphics Processor	<ul style="list-style-type: none"> • Intel® UHD Graphics 630 • Independent Graphics : By request
Interface	Up to 7 independent displays : <ul style="list-style-type: none"> • 1 DVI : Up to 1920 x 1200 @60Hz • 1 DisplayPort : Up to 4096 x 2304 @60Hz • 1 Digital Display : Up to 1920×1080 @60Hz • By requested Graphics Card
Storage	
SATA	4 SATA III (6Gbps) support software RAID 0, 1, 5, 10
mSATA	2 SATA III (Mini PCIe Type, 6Gbps)
Storage Device	<ul style="list-style-type: none"> • 4 Front-access 2.5" SSD/HDD Tray • 1 M.2 Key M Socket
Audio	
Audio Codec	Realtek ALC888S-VD, 7.1 Channel HD Audio
Audio Interface	1 Mic-in, 1 Line-out

Ethernet	
LAN 1	Intel® I219LM Gigabit LAN supports iAMT 12.0
LAN 2	Intel® I210 Gigabit LAN
Power	
Input Voltage	<ul style="list-style-type: none"> • 24V to 36V, DC-in • 12V DC-in (Optional)
Power Interface	3-pin Terminal Block : V+, V-, Frame Ground
Ignition Control	16 Mode (Internal)
Remote Switch	3-pin Terminal Block : On, Off, IGN
Surge Protection	Up to 80V/1ms Transient Power
Others	
TPM	Optional Infineon SLB9665 supports TPM 2.0, LPC interface
Watchdog Timer	Reset : 1 to 255 sec./min. per step
Smart Management	Wake on LAN, PXE supported
HW Monitor	Monitoring temperature, voltages. Auto throttling control when CPU overheats.
Software Support	
OS	Windows 10, Linux
Mechanical	
Dimension	330.0mm x 210.0mm x 172.0mm (12.99" x 8.27" x 6.77")
Weight	6.8 kg (15 lb)
Mounting	Wallmount by mounting bracket
Environment	
Operating Temperature	-25°C to 45°C (-13°F to 113°F)
Storage Temperature	-40°C to 85°C (-40°F to 185°F)
Humidity	5% to 95% humidity, non-condensing
Relative Humidity	95% at 45°C
Shock	<ul style="list-style-type: none"> • IEC 60068-2-27 • SSD : 50G @wallmount, Half-sine, 11ms
Vibration	<ul style="list-style-type: none"> • IEC 60068-2-64 • SSD : 5Grms, 5Hz to 500Hz, 3 Axis
EMC	CE, FCC, EN50155, EN50121-3-2

1.3.17 Specifications of RCX-1430F PEG

System	
Processor	8 cores Intel® Xeon®/Core™ i7/i5/i3 Processor (Coffee Lake Refresh)
Chipset	Intel® C246 Chipset
BIOS	AMI
SIO	IT8786E
Memory	<ul style="list-style-type: none"> • DDR4 2666MHz (ECC/Non-ECC) • Up to 128GB • 4 260-pin SO-DIMM Socket
I/O Interface	
Serial	4 COM RS-232/422/485 (ESD 8KV)
USB	<ul style="list-style-type: none"> • 6 USB 3.1 Gen 2 (External) • 1 USB 2.0 (Internal)
Isolated DIO	32 Isolated DIO : 16 DI, 16 DO
LED	Power, HDD, Wireless
SIM Card	2 External SIM Card Socket
Expansion	
Mini PCIe	2 Full-size for PCIe/USB/External SIM Card/mSATA
PCI/PCIe	<ul style="list-style-type: none"> • 1 PCIe x16 Slot • 1 PCIe x16 Slot with x4 signal • 1 PCIe x16 Slot with x1 signal
M.2	1 M.2 Key E Socket
Graphics	
Graphics Processor	<ul style="list-style-type: none"> • Intel® UHD Graphics 630 • Independent Graphics : By request
Interface	Up to 7 independent displays : <ul style="list-style-type: none"> • 1 DVI : Up to 1920 x 1200 @60Hz • 1 DisplayPort : Up to 4096 x 2304 @60Hz • 1 Digital Display : Up to 1920×1080 @60Hz • By requested Graphics Card
Storage	
SATA	4 SATA III (6Gbps) support software RAID 0, 1, 5, 10
mSATA	2 SATA III (Mini PCIe Type, 6Gbps)
Storage Device	<ul style="list-style-type: none"> • 4 2.5" SSD/HDD Bracket (Internal) • 1 M.2 Key M Socket
Audio	
Audio Codec	Realtek ALC888S-VD, 7.1 Channel HD Audio
Audio Interface	1 Mic-in, 1 Line-out

Ethernet	
LAN 1	Intel® I219LM Gigabit LAN supports iAMT 12.0
LAN 2	Intel® I210 Gigabit LAN
Power	
Input Voltage	<ul style="list-style-type: none"> • 24V to 36V, DC-in • 12V DC-in (Optional)
Power Interface	3-pin Terminal Block : V+, V-, Frame Ground
Ignition Control	16 Mode (Internal)
Remote Switch	3-pin Terminal Block : On, Off, IGN
Surge Protection	Up to 80V/1ms Transient Power
Others	
TPM	Optional Infineon SLB9665 supports TPM 2.0, LPC interface
Watchdog Timer	Reset : 1 to 255 sec./min. per step
Smart Management	Wake on LAN, PXE supported
HW Monitor	Monitoring temperature, voltages. Auto throttling control when CPU overheats.
Software Support	
OS	Windows 10, Linux
Mechanical	
Dimension	330.0mm x 210.0mm x 172.0mm (12.99" x 8.27" x 6.77")
Weight	6.4 kg (14.1 lb)
Mounting	Wallmount by mounting bracket
Environment	
Operating Temperature	-25°C to 45°C (-13°F to 113°F)
Storage Temperature	-40°C to 85°C (-40°F to 185°F)
Humidity	5% to 95% humidity, non-condensing
Relative Humidity	95% at 45°C
Shock	<ul style="list-style-type: none"> • IEC 60068-2-27 • SSD : 50G @wallmount, Half-sine, 11ms
Vibration	<ul style="list-style-type: none"> • IEC 60068-2-64 • SSD : 5Grms, 5Hz to 500Hz, 3 Axis
EMC	CE, FCC, EN50155, EN50121-3-2

1.3.18 Specifications of RCX-1421FR PEG

System	
Processor	8 cores Intel® Xeon®/Core™ i7/i5/i3 Processor (Coffee Lake Refresh)
Chipset	Intel® C246 Chipset
BIOS	AMI
SIO	IT8786E
Memory	<ul style="list-style-type: none"> • DDR4 2666MHz (ECC/Non-ECC) • Up to 128GB • 4 260-pin SO-DIMM Socket
I/O Interface	
Serial	4 COM RS-232/422/485 (ESD 8KV)
USB	<ul style="list-style-type: none"> • 6 USB 3.1 Gen 2 (External) • 1 USB 2.0 (Internal)
Isolated DIO	32 Isolated DIO : 16 DI, 16 DO
LED	Power, HDD, Wireless
SIM Card	2 External SIM Card Socket
Expansion	
Mini PCIe	2 Full-size for PCIe/USB/External SIM Card/mSATA
PCI/PCIe	<ul style="list-style-type: none"> • 1 PCIe x16 Slot • 1 PCIe x16 Slot with x4 Signal • 1 PCI Slot
M.2	1 M.2 Key E Socket
Graphics	
Graphics Processor	<ul style="list-style-type: none"> • Intel® UHD Graphics 630 • Independent Graphics : By request
Interface	Up to 7 independent displays : <ul style="list-style-type: none"> • 1 DVI : Up to 1920 x 1200 @60Hz • 1 DisplayPort : Up to 4096 x 2304 @60Hz • 1 Digital Display : Up to 1920x1080 @60Hz • By requested Graphics Card
Storage	
SATA	4 SATA III (6Gbps) support software RAID 0, 1, 5, 10
mSATA	2 SATA III (Mini PCIe Type, 6Gbps)
Storage Device	<ul style="list-style-type: none"> • 4 Front-access 2.5" SSD/HDD Tray • 1 M.2 Key M Socket
Audio	
Audio Codec	Realtek ALC888S-VD, 7.1 Channel HD Audio
Audio Interface	1 Mic-in, 1 Line-out

Ethernet	
LAN 1	Intel® I219LM Gigabit LAN supports iAMT 12.0
LAN 2	Intel® I210 Gigabit LAN
Power	
Input Voltage	<ul style="list-style-type: none"> • 24V to 36V, DC-in • 12V DC-in (Optional)
Power Interface	3-pin Terminal Block : V+, V-, Frame Ground
Ignition Control	16 Mode (Internal)
Remote Switch	3-pin Terminal Block : On, Off, IGN
Surge Protection	Up to 80V/1ms Transient Power
Others	
TPM	Optional Infineon SLB9665 supports TPM 2.0, LPC interface
Watchdog Timer	Reset : 1 to 255 sec./min. per step
Smart Management	Wake on LAN, PXE supported
HW Monitor	Monitoring temperature, voltages. Auto throttling control when CPU overheats.
Software Support	
OS	Windows 10, Linux
Mechanical	
Dimension	330.0mm x 210.0mm x 172.0mm (12.99" x 8.27" x 6.77")
Weight	6.8 kg (15 lb)
Mounting	Wallmount by mounting bracket
Environment	
Operating Temperature	-25°C to 45°C (-13°F to 113°F)
Storage Temperature	-40°C to 85°C (-40°F to 185°F)
Humidity	5% to 95% humidity, non-condensing
Relative Humidity	95% at 45°C
Shock / Vibration	<ul style="list-style-type: none"> • IEC 61373 : 2010 • Railway Applications : Rolling Stock Equipment, Shock and Vibration Tests
EMC	CE, FCC, EN50155, EN50121-3-2

1.3.19 Specifications of RCX-1430F PEG

System	
Processor	8 cores Intel® Xeon®/Core™ i7/i5/i3 Processor (Coffee Lake Refresh)
Chipset	Intel® C246 Chipset
BIOS	AMI
SIO	IT8786E
Memory	<ul style="list-style-type: none"> • DDR4 2666MHz (ECC/Non-ECC) • Up to 128GB • 4 260-pin SO-DIMM Socket
I/O Interface	
Serial	4 COM RS-232/422/485 (ESD 8KV)
USB	<ul style="list-style-type: none"> • 6 USB 3.1 Gen 2 (External) • 1 USB 2.0 (Internal)
Isolated DIO	32 Isolated DIO : 16 DI, 16 DO
LED	Power, HDD, Wireless
SIM Card	2 External SIM Card Socket
Expansion	
Mini PCIe	2 Full-size for PCIe/USB/External SIM Card/mSATA
PCI/PCIe	<ul style="list-style-type: none"> • 1 PCIe x16 Slot • 1 PCIe x16 Slot with x4 signal • 1 PCI Slot
M.2	1 M.2 Key E Socket
Graphics	
Graphics Processor	<ul style="list-style-type: none"> • Intel® UHD Graphics 630 • Independent Graphics : By request
Interface	Up to 7 independent displays : <ul style="list-style-type: none"> • 1 DVI : Up to 1920 x 1200 @60Hz • 1 DisplayPort : Up to 4096 x 2304 @60Hz • 1 Digital Display : Up to 1920×1080 @60Hz • By requested Graphics Card
Storage	
SATA	4 SATA III (6Gbps) support software RAID 0, 1, 5, 10
mSATA	2 SATA III (Mini PCIe Type, 6Gbps)
Storage Device	<ul style="list-style-type: none"> • 4 2.5" SSD/HDD Bracket (Internal) • 1 M.2 Key M Socket
Audio	
Audio Codec	Realtek ALC888S-VD, 7.1 Channel HD Audio
Audio Interface	1 Mic-in, 1 Line-out

Ethernet	
LAN 1	Intel® I219LM Gigabit LAN supports iAMT 12.0
LAN 2	Intel® I210 Gigabit LAN
Power	
Input Voltage	<ul style="list-style-type: none"> • 24V to 36V, DC-in • 12V DC-in (Optional)
Power Interface	3-pin Terminal Block : V+, V-, Frame Ground
Ignition Control	16 Mode (Internal)
Remote Switch	3-pin Terminal Block : On, Off, IGN
Surge Protection	Up to 80V/1ms Transient Power
Others	
TPM	Optional Infineon SLB9665 supports TPM 2.0, LPC interface
Watchdog Timer	Reset : 1 to 255 sec./min. per step
Smart Management	Wake on LAN, PXE supported
HW Monitor	Monitoring temperature, voltages. Auto throttling control when CPU overheats.
Software Support	
OS	Windows 10, Linux
Mechanical	
Dimension	330.0mm x 210.0mm x 172.0mm (12.99" x 8.27" x 6.77")
Weight	6.4 kg (14.1 lb)
Mounting	Wallmount by mounting bracket
Environment	
Operating Temperature	-25°C to 45°C (-13°F to 113°F)
Storage Temperature	-40°C to 85°C (-40°F to 185°F)
Humidity	5% to 95% humidity, non-condensing
Relative Humidity	95% at 45°C
Shock / Vibration	<ul style="list-style-type: none"> • IEC 61373 : 2010 • Railway Applications : Rolling Stock Equipment, Shock and Vibration Tests
EMC	CE, FCC, EN50155, EN50121-3-2

1.3.20 Specifications of RCX-1412FR PEG

System	
Processor	8 cores Intel®Xeon®/Core™ i7/i5/i3 Processor (Coffee Lake Refresh)
Chipset	Intel® C246 Chipset
BIOS	AMI
SIO	IT8786E
Memory	<ul style="list-style-type: none"> • DDR4 2666MHz (ECC/Non-ECC) • Up to 128GB • 4 260-pin SO-DIMM Socket
I/O Interface	
Serial	4 COM RS-232/422/485 (ESD 8KV)
USB	<ul style="list-style-type: none"> • 6 USB 3.1 Gen 2 (External) • 1 USB 2.0 (Internal)
Isolated DIO	32 Isolated DIO : 16 DI, 16 DO
LED	Power, HDD, Wireless
SIM Card	2 External SIM Card Socket
Expansion	
Mini PCIe	2 Full-size for PCIe/USB/External SIM Card/mSATA
PCI/PCIe	<ul style="list-style-type: none"> • 1 PCIe x16 Slot • 2 PCI Slot
M.2	1 M.2 Key E Socket
Graphics	
Graphics Processor	<ul style="list-style-type: none"> • Intel® UHD Graphics 630 • Independent Graphics : By request
Interface	Up to 7 independent displays : <ul style="list-style-type: none"> • 1 DVI : Up to 1920 x 1200 @60Hz • 1 DisplayPort : Up to 4096 x 2304 @60Hz • 1 Digital Display : Up to 1920x1080 @60Hz • By requested Graphics Card
Storage	
SATA	4 SATA III (6Gbps) support software RAID 0, 1, 5, 10
mSATA	2 SATA III (Mini PCIe Type, 6Gbps)
Storage Device	<ul style="list-style-type: none"> • 4 Front-access 2.5" SSD/HDD Tray • 1 M.2 Key M Socket
Audio	
Audio Codec	Realtek ALC888S-VD, 7.1 Channel HD Audio
Audio Interface	1 Mic-in, 1 Line-out

Ethernet	
LAN 1	Intel® I219LM Gigabit LAN supports iAMT 12.0
LAN 2	Intel® I210 Gigabit LAN
Power	
Input Voltage	<ul style="list-style-type: none"> • 24V to 36V, DC-in • 12V DC-in (Optional)
Power Interface	3-pin Terminal Block : V+, V-, Frame Ground
Ignition Control	16 Mode (Internal)
Remote Switch	3-pin Terminal Block : On, Off, IGN
Surge Protection	Up to 80V/1ms Transient Power
Others	
TPM	Optional Infineon SLB9665 supports TPM 2.0, LPC interface
Watchdog Timer	Reset : 1 to 255 sec./min. per step
Smart Management	Wake on LAN, PXE supported
HW Monitor	Monitoring temperature, voltages. Auto throttling control when CPU overheats.
Software Support	
OS	Windows 10, Linux
Mechanical	
Dimension	330.0mm x 210.0mm x 172.0mm (12.99" x 8.27" x 6.77")
Weight	6.8 kg (15 lb)
Mounting	Wallmount by mounting bracket
Environment	
Operating Temperature	-25°C to 45°C (-13°F to 113°F)
Storage Temperature	-40°C to 85°C (-40°F to 185°F)
Humidity	5% to 95% humidity, non-condensing
Relative Humidity	95% at 45°C
Shock / Vibration	<ul style="list-style-type: none"> • IEC 61373 : 2010 • Railway Applications : Rolling Stock Equipment, Shock and Vibration Tests
EMC	CE, FCC, EN50155, EN50121-3-2

1.3.21 Specifications of RCX-1412F PEG

System	
Processor	8 cores Intel®Xeon®/Core™ i7/i5/i3 Processor (Coffee Lake Refresh)
Chipset	Intel® C246 Chipset
BIOS	AMI
SIO	IT8786E
Memory	<ul style="list-style-type: none"> • DDR4 2666MHz (ECC/Non-ECC) • Up to 128GB • 4 260-pin SO-DIMM Socket
I/O Interface	
Serial	4 COM RS-232/422/485 (ESD 8KV)
USB	<ul style="list-style-type: none"> • 6 USB 3.1 Gen 2 (External) • 1 USB 2.0 (Internal)
Isolated DIO	32 Isolated DIO : 16 DI, 16 DO
LED	Power, HDD, Wireless
SIM Card	2 External SIM Card Socket
Expansion	
Mini PCIe	2 Full-size for PCIe/USB/External SIM Card/mSATA
PCI/PCIe	<ul style="list-style-type: none"> • 1 PCIe x16 Slot • 2 PCI Slot
M.2	1 M.2 Key E Socket
Graphics	
Graphics Processor	<ul style="list-style-type: none"> • Intel® UHD Graphics 630 • Independent Graphics : By request
Interface	Up to 7 independent displays : <ul style="list-style-type: none"> • 1 DVI : Up to 1920 x 1200 @60Hz • 1 DisplayPort : Up to 4096 x 2304 @60Hz • 1 Digital Display : Up to 1920x1080 @60Hz • By requested Graphics Card
Storage	
SATA	4 SATA III (6Gbps) support software RAID 0, 1, 5, 10
mSATA	2 SATA III (Mini PCIe Type, 6Gbps)
Storage Device	<ul style="list-style-type: none"> • 4 2.5" SSD/HDD Bracket (Internal) • 1 M.2 Key M Socket
Audio	
Audio Codec	Realtek ALC888S-VD, 7.1 Channel HD Audio
Audio Interface	1 Mic-in, 1 Line-out

Ethernet	
LAN 1	Intel® I219LM Gigabit LAN supports iAMT 12.0
LAN 2	Intel® I210 Gigabit LAN
Power	
Input Voltage	<ul style="list-style-type: none"> • 24V to 36V, DC-in • 12V DC-in (Optional)
Power Interface	3-pin Terminal Block : V+, V-, Frame Ground
Ignition Control	16 Mode (Internal)
Remote Switch	3-pin Terminal Block : On, Off, IGN
Surge Protection	Up to 80V/1ms Transient Power
Others	
TPM	Optional Infineon SLB9665 supports TPM 2.0, LPC interface
Watchdog Timer	Reset : 1 to 255 sec./min. per step
Smart Management	Wake on LAN, PXE supported
HW Monitor	Monitoring temperature, voltages. Auto throttling control when CPU overheats.
Software Support	
OS	Windows 10, Linux
Mechanical	
Dimension	330.0mm x 210.0mm x 172.0mm (12.99" x 8.27" x 6.77")
Weight	6.4 kg (14.1 lb)
Mounting	Wallmount by mounting bracket
Environment	
Operating Temperature	-25°C to 45°C (-13°F to 113°F)
Storage Temperature	-40°C to 85°C (-40°F to 185°F)
Humidity	5% to 95% humidity, non-condensing
Relative Humidity	95% at 45°C
Shock / Vibration	<ul style="list-style-type: none"> • IEC 61373 : 2010 • Railway Applications : Rolling Stock Equipment, Shock and Vibration Tests
EMC	CE, FCC, EN50155, EN50121-3-2

1.4 Supported CPU List

Series	CPU	Cores	GHz	TDP (W)	CPU	Cores	GHz	TDP (W)	ECC RAM
Intel® Xeon®	E-2176G	6	4.6	80	E-2278GE	8	4.7	80	Yes
					E-2278GEL	8	3.9	35	
	E-2124G	4	4.5	71	E-2226GE	6	4.6	80	
Intel® Core™	i7-8700	6	4.6	65	i7-9700E	8	4.4	65	N/A
	i7-8700T	6	4	35	i7-9700TE		3.8	35	
	i5-8500	6	4.1	65	i5-9500E	6	4.2	65	
	i5-8500T	6	3.5	35	i5-9500TE		3.6	35	
	i3-8100	4	3.6	65	i3-9100E	4	3.7	65	Yes
	i3-8100T	4	3.1	35	i3-9100TE		3.2	35	

1.5 Mechanical Dimension

1.5.1 Dimensions of RCX-1400FR/RCX-1000FR PEG

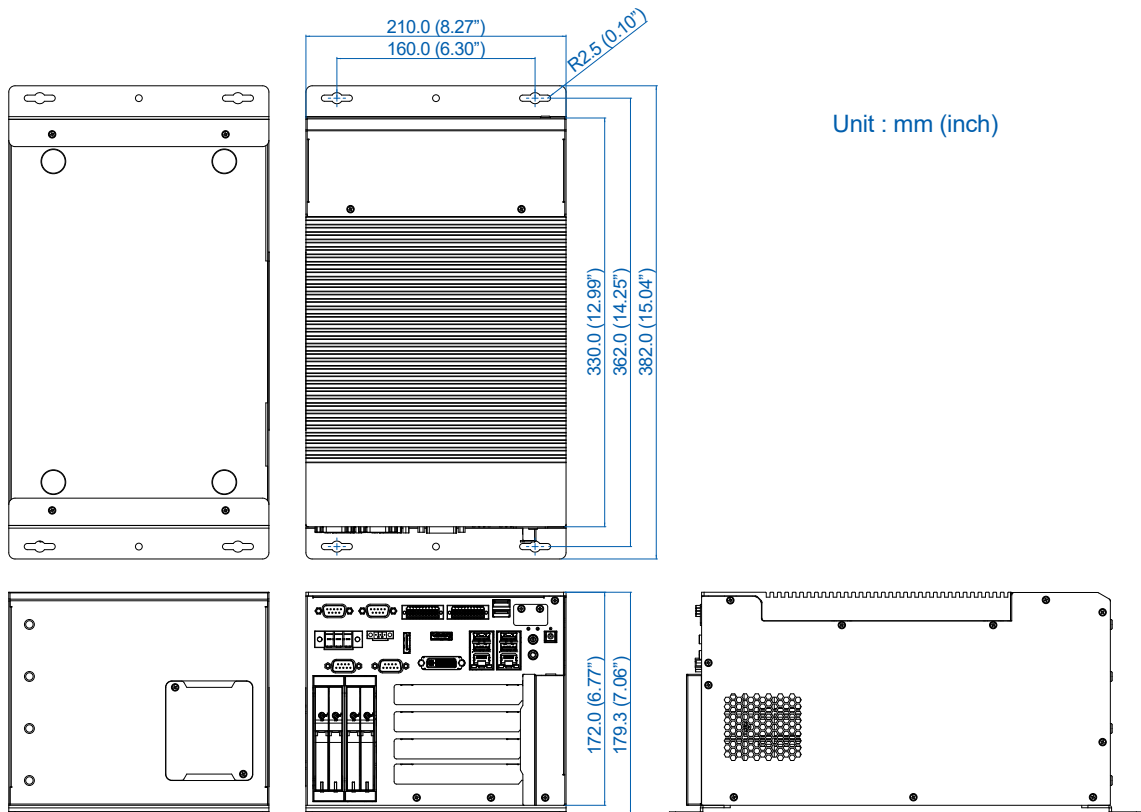

1.5.2 Dimensions of RCX-1400F/RCX-1000F PEG

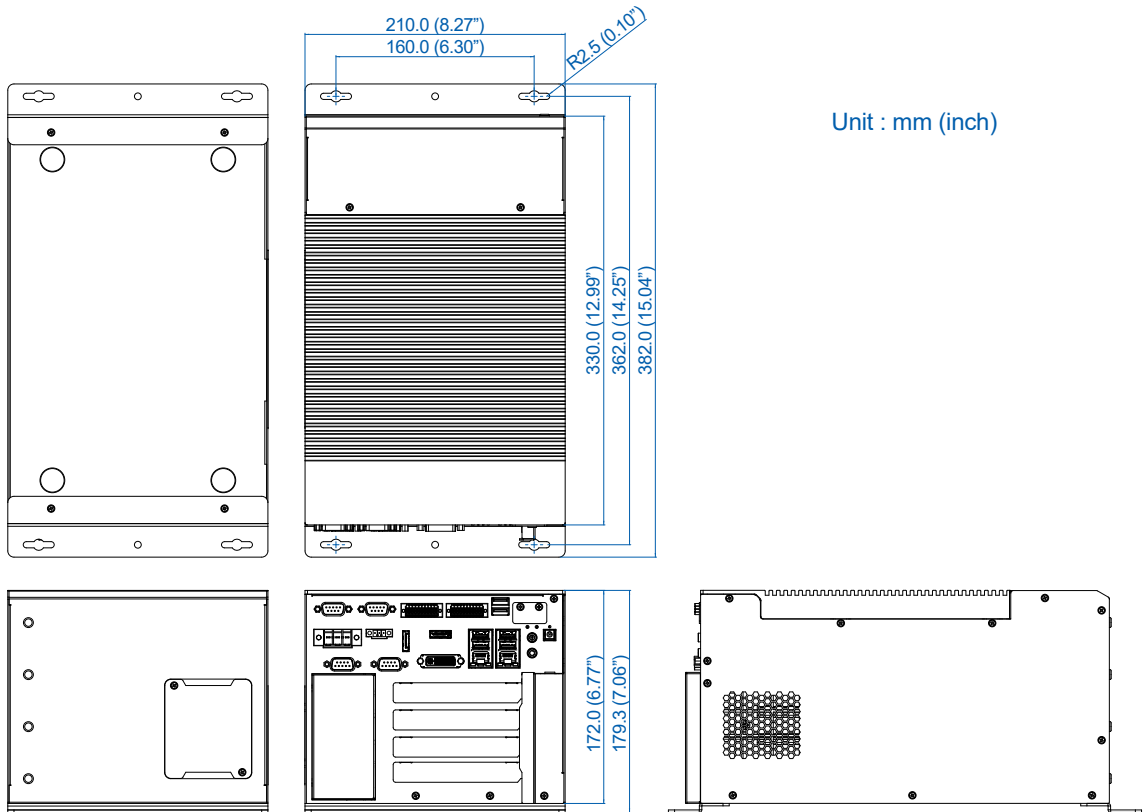

1.5.3 Dimensions of RCX-1440R/RCX-1422R/RCX-1404R

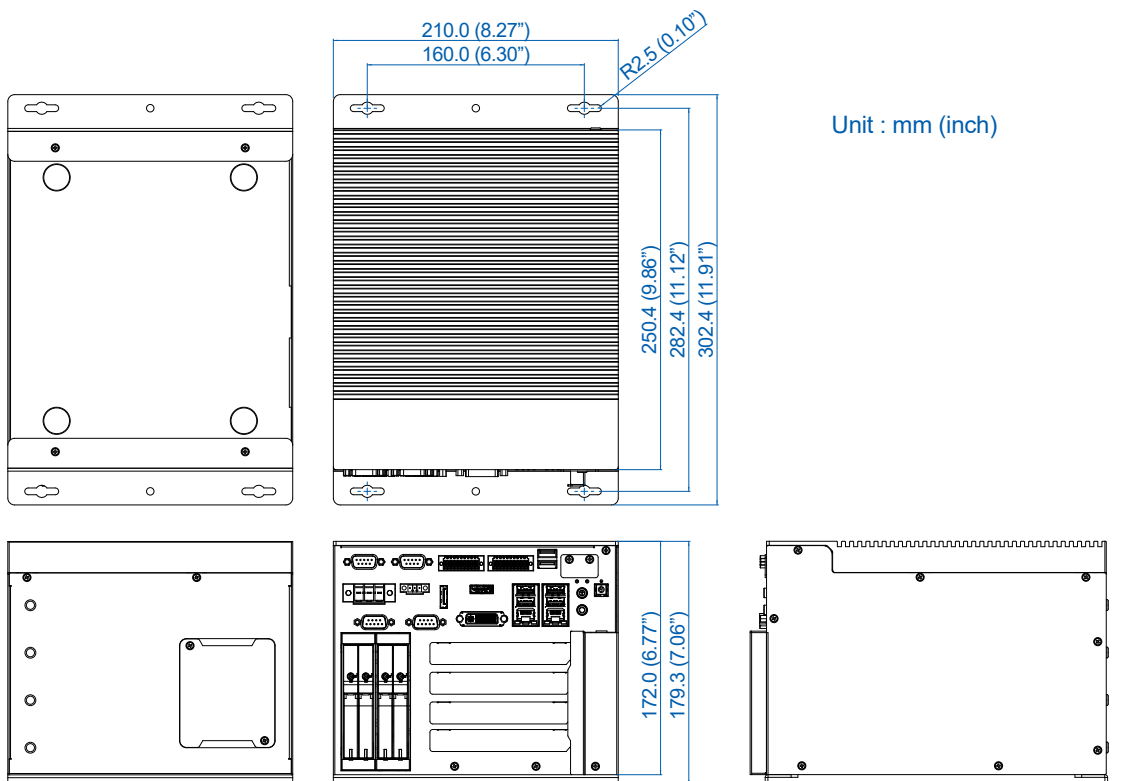

1.5.4 Dimensions of RCX-1440/RCX-1422/RCX-1404

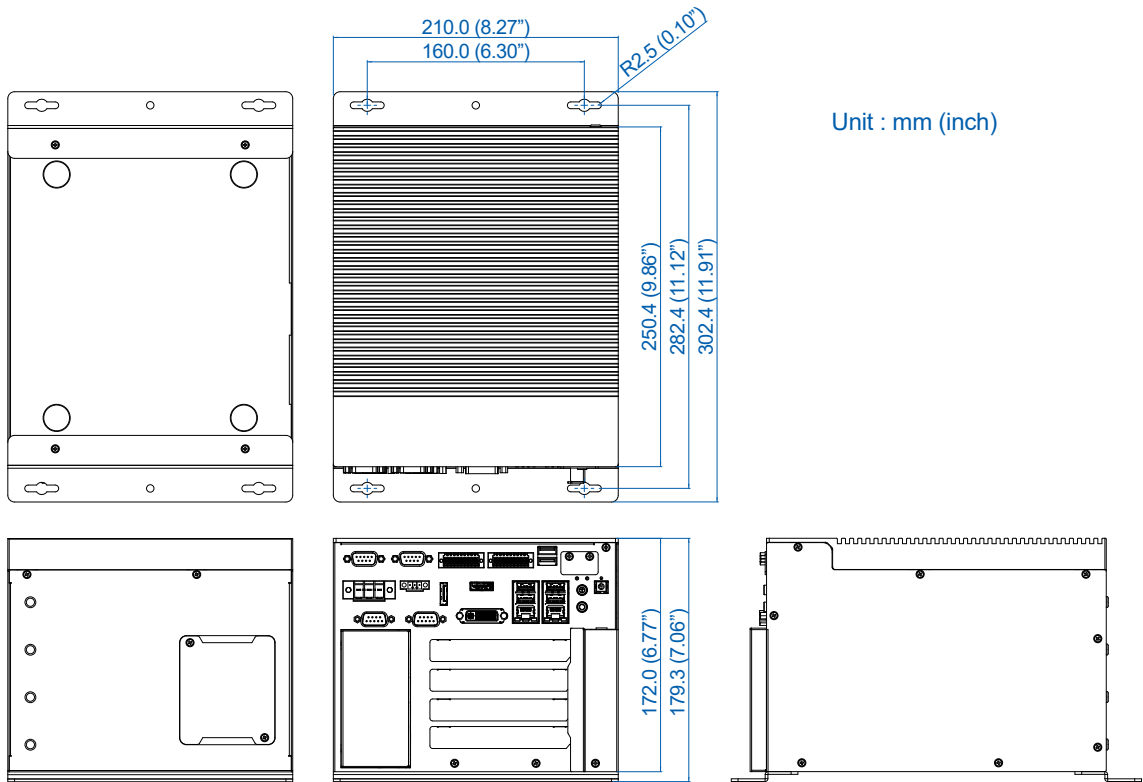

1.5.5 Dimensions of RCX-1220A/RCX-1220/RCX-1211

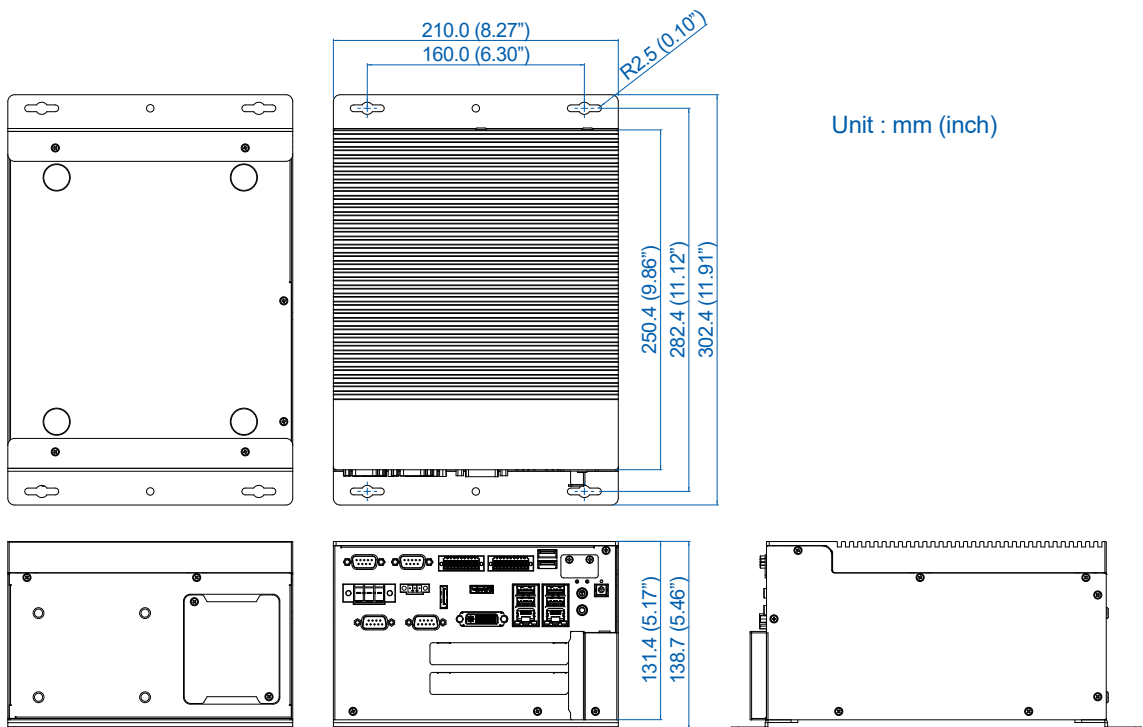

2

GETTING TO KNOW YOUR RCX-1000

2.1 Packing List

Item	Description	Qty
1	RCX-1000 Fanless Robust Computing System (According to the configuration you order, the RCX-1000 series may contain SSD/HDD and DDR4 SO-DIMM. Please verify these items if necessary.)	1
2	RCX-1400FR Series Accessory box, which contains <ul style="list-style-type: none">• Vecow Drivers & Utilities DVD• Wall-mounting bracket• F Head #6-32x6 screw (for wall-mounting bracket)• PH Head M2.5x6 screw (for Mini PCIe Slot)• PH Head M3x6 screw (for M.2 Slot)• Terminal block plug pitch 2.54mm 2x10pin• Terminal block 3-pin (7.62mm)• Terminal block 3-pin (3.5mm)• Foot Pad• EPE• Plastic Bag	1 2 4 2 2 2 1 1 4 2 1
3	RCX-1400F Series Accessory box, which contains <ul style="list-style-type: none">• Vecow Drivers & Utilities DVD• Wall-mounting bracket• F#6-32x6 screw for wall-mounting bracket• PH-M2.5x6 screw for Mini PCIe Slot• PH-M4x16.5 for wall-mounting bracket• Terminal block plug pitch 2.54mm 2x10pin• Terminal block 3-pin (7.62mm)• Terminal block 3-pin (3.5mm)• Foot Pad• EPE• Plastic Bag• F-M3x4 for SSD/HDD with bracket	1 2 4 6 4 2 1 1 4 2 1 16

Item	Description	Qty
4	RCX-1400R Series Accessory box, which contains <ul style="list-style-type: none"> • Vecow Drivers & Utilities DVD • Wall-mounting bracket • F#6-32x6 screw for wall-mounting bracket • PH-M2.5x6 screw for Mini PCIe Slot • PH-M4x16.5 for wall-mounting bracket • Terminal block plug pitch 2.54mm 2x10pin • Terminal block 3-pin (7.62mm) • Terminal block 3-pin (3.5mm) • Foot Pad • EPE • Plastic Bag • Removable HDD Tray Key 	1 2 4 6 4 2 1 1 4 2 1 2
5	RCX-1200/1400 Series Accessory box, which contains <ul style="list-style-type: none"> • Vecow Drivers & Utilities DVD • Wall-mounting bracket • F#6-32x6 screw for wall-mounting bracket • PH-M2.5x6 screw for Mini PCIe Slot • PH-M4x16.5 for wall-mounting bracket • Terminal block plug pitch 2.54mm 2x10pin • Terminal block 3-pin (7.62mm) • Terminal block 3-pin (3.5mm) • Foot Pad • EPE • Plastic Bag • Removable HDD Tray Key • F-M3x4 for SSD/HDD with bracket 	1 2 4 6 4 2 1 1 4 2 1 2 16

2.2 Front Panel I/O Functions

In Vecow's RCX-1000 series family, all I/O connectors are located on the front panel. Most of the general connections to the computer device, such as audio, USB, DVI-I, COM Port, Isolated DIO, Display Port, and any additional storage, are placed on the front panel.

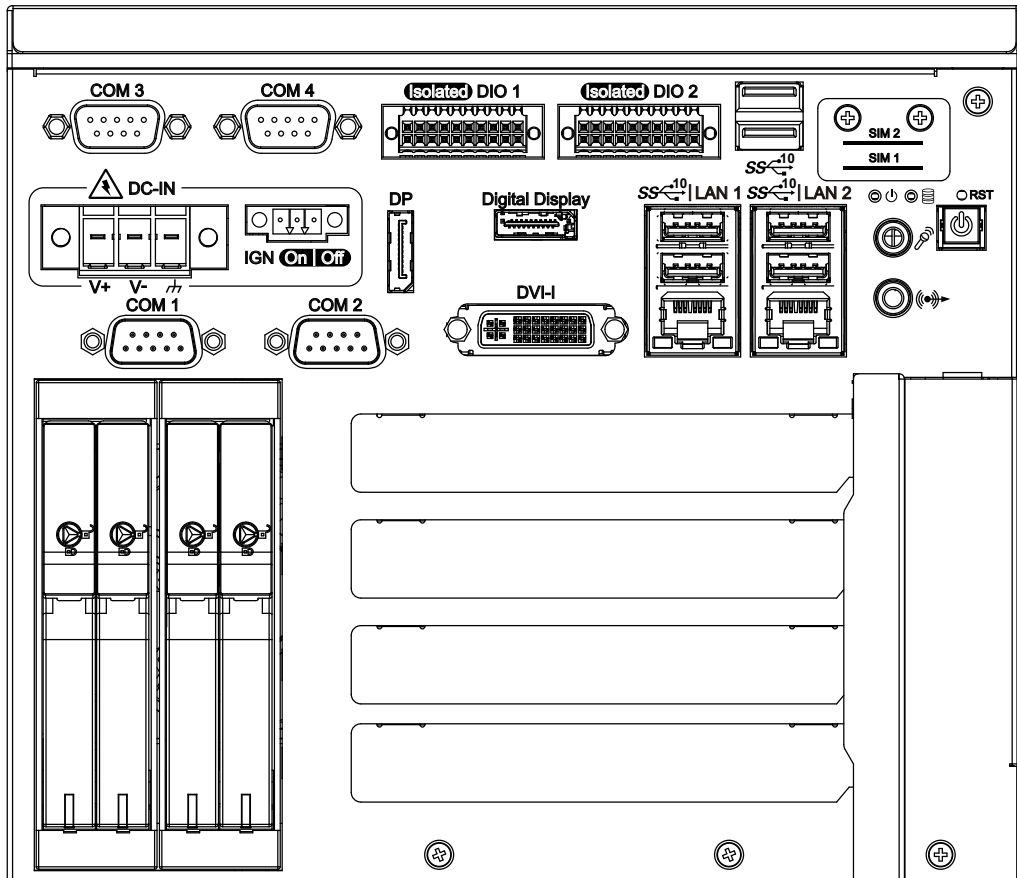

2.2.1 Reset Tact Switch

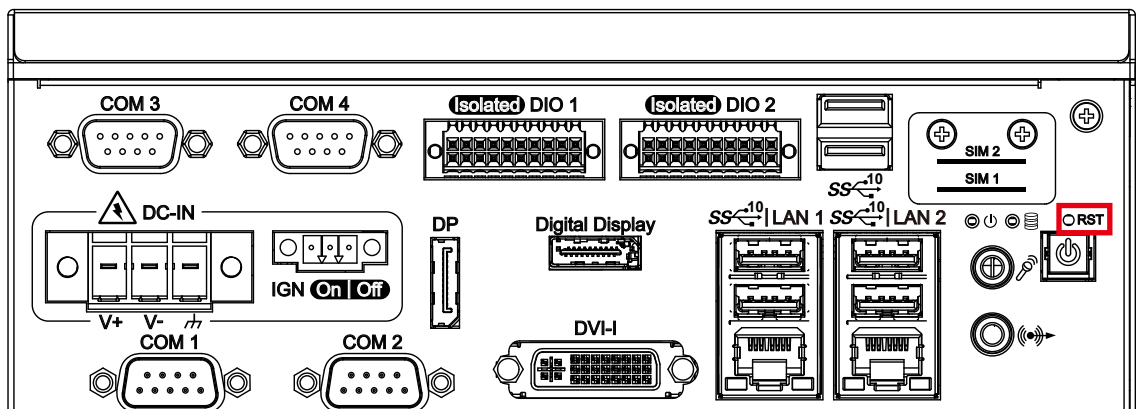

The item circled in red is a hardware reset switch. Use this switch to reset the system without powering off the RCX-1000. Press and hold the reset switch for a few seconds, then reset will be enabled.

2.2.2 Power Button

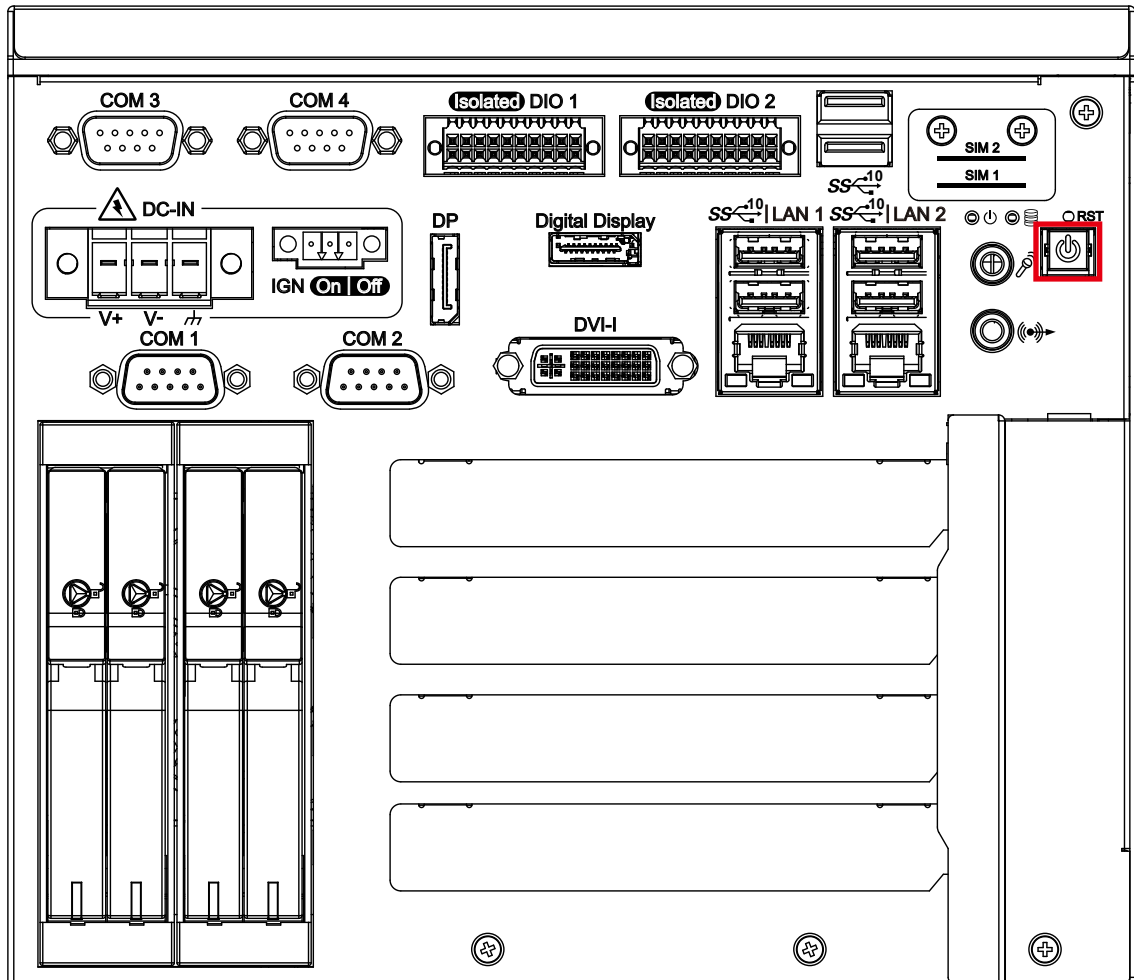

The power button is a non-latched switch with dual color LED indicators. It indicates power statuses : S0, S3 and S5. More details on the LED indicators are listed in the following chart :

LED Color	Power Status	System Status
Solid Blue	S0	System working
Solid Orange	S3, S5	Suspend to RAM, System off with standby power

To power on RCX-1000, press the power button which will light the blue LED. To power off RCX-1000, you can either command shutdown by OS operation or simply press the power button. If system error appears, press and hold the power button for four seconds to shut down the machine directly.

Please do note that a four-second interval between each two power-on/power-off operation is necessary in normal working status. (For example, once turning off the system, you have to wait for four seconds to initiate another power-on operation).

2.2.3 PWR & HDD LED Indicator

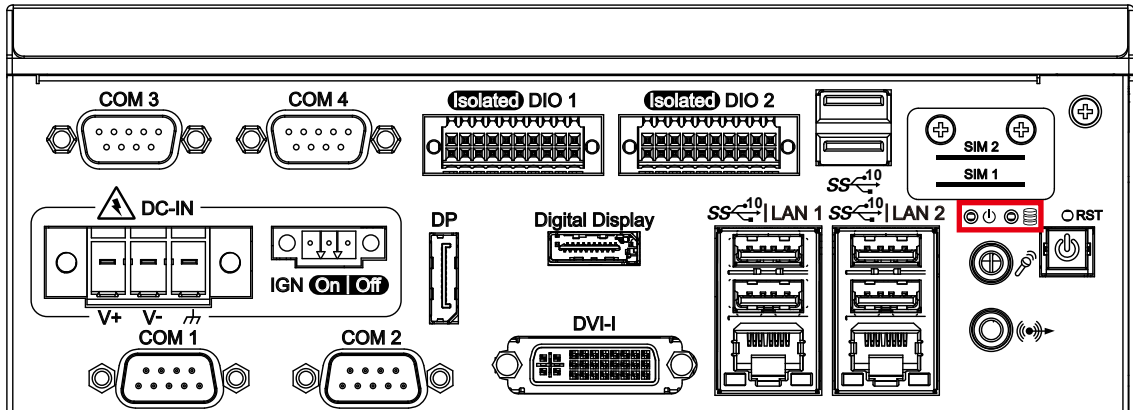

Yellow-HDD LED : A hard disk LED. If the LED is on, it indicates that the system's storage is functional. If it is off, it indicates that the system's storage is not functional. If it is flashing, it indicates data access activities are in progress.

Green-Power LED : If the LED is solid green, it indicates that the system is powered on.

LED Color	Indication	System Status
Yellow	HDD	<ul style="list-style-type: none"> On/Off : Storage status, function or not. Twinkling : Data transferring.
Green	Power	System power status (on/off)

2.2.4 DVI-D Connector

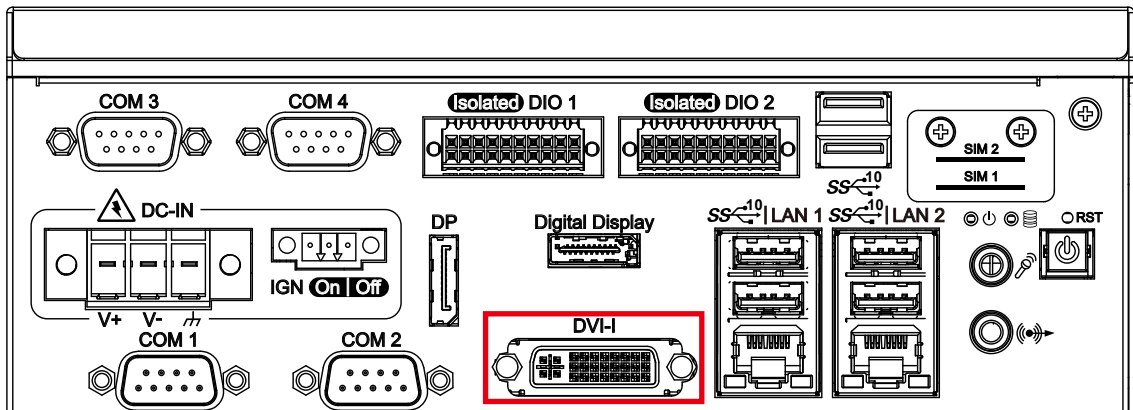

The DVI-I connector on the front panel supports both DVI and VGA display modes. This connector can output DVI signals. The DVI output mode supports up to 1920x1200 resolution. The DVI mode is automatically selected according to the display device connected. You will need a DVI-I cable when connecting to a display device. The VGA output mode supports up to 1920x1200 resolution. To utilize the VGA function, you will need a DVII to VGA module connecting to DVI-I device.

Right is the DVII to VGA module picture



2.2.5 DisplayPort

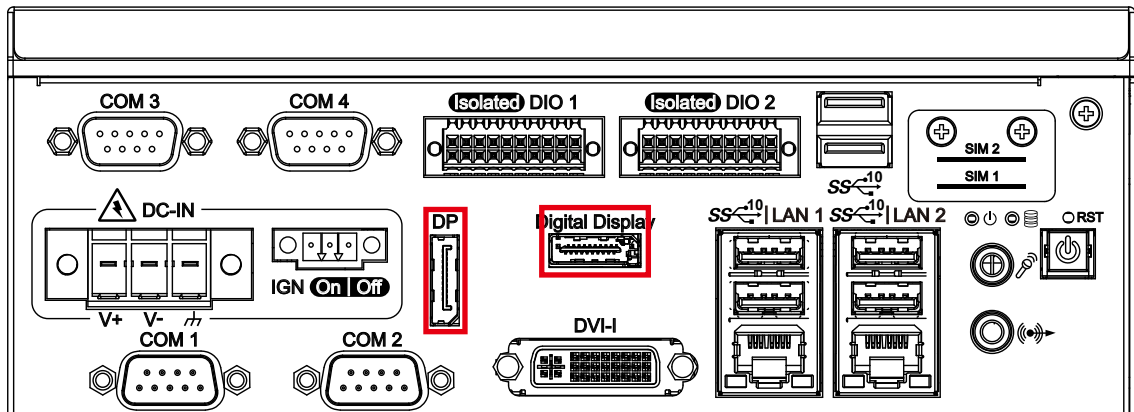

Display Port support 4096x2304 resolution at 60Hz.

Digital Display support HDMI 1920x1080 resolution at 60Hz.

2.2.6 USB 3.1

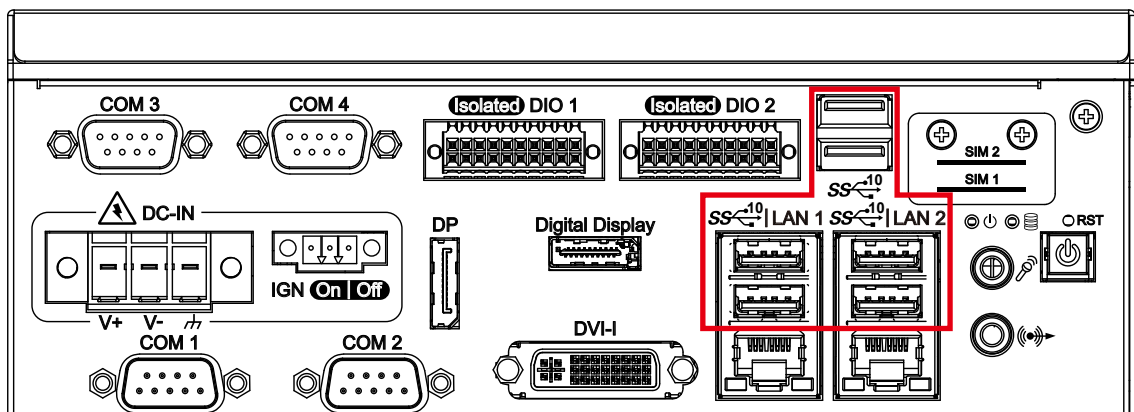

There are 6 USB 3.1 connections available supporting up to 10GB per second data rate in the front side of RCX-1000 series. It is also compliant with the requirements of Super Speed (SS), high speed (HS), full speed (FS) and low speed (LS).

2.2.7 SIM 1, SIM 2

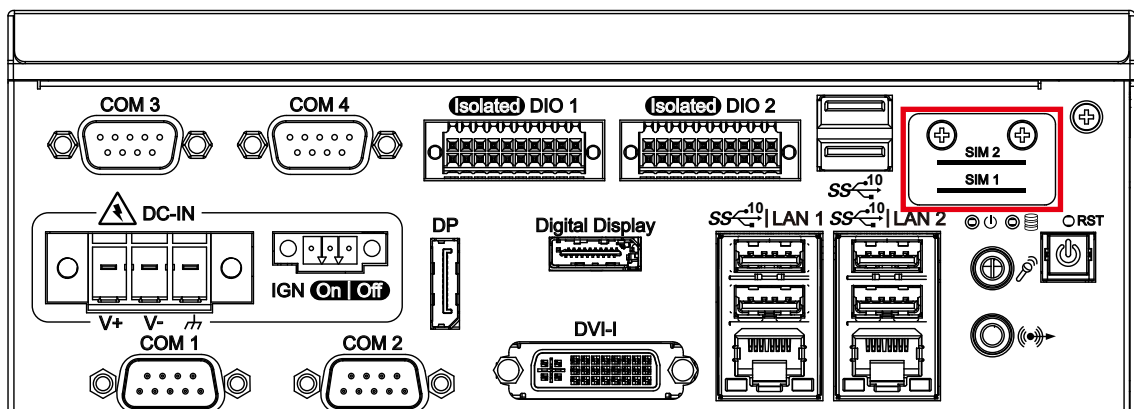

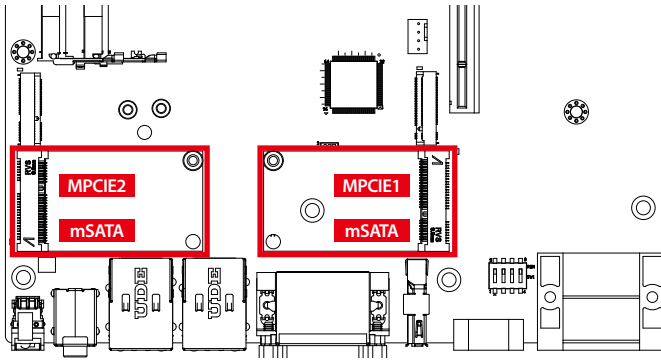

m-PCIE	SIM
MPCIE1	SIM1
MPCIE2	SIM2

2.2.8 10/100/1000 Mbps Ethernet Port

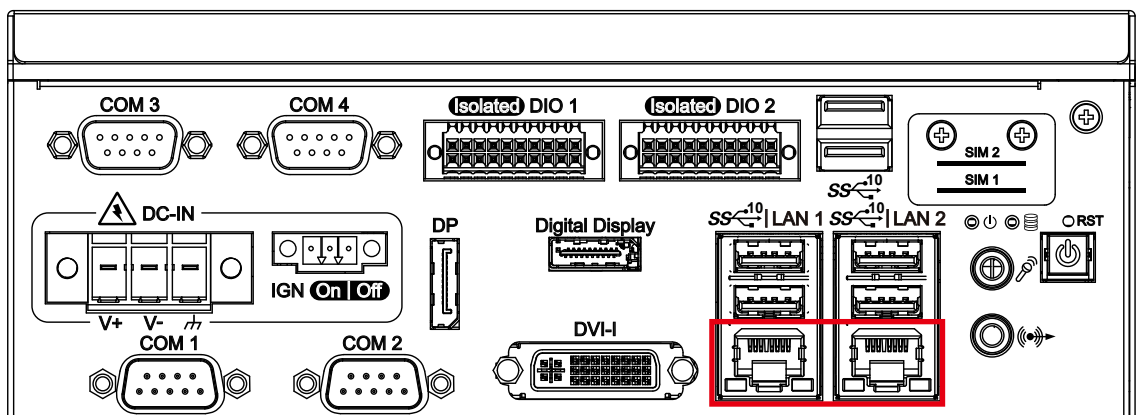

There are two 8-pin RJ-45 jacks supporting 10/100/1000 Mbps Ethernet connections on the front side of RCX-1000. LAN 1 is powered by Intel® I219LM Ethernet engine, and LAN 2 is powered by Intel® I210 Ethernet engine. When LAN 1 works in normal status, iAMT 11.0 function is enabled. When LAN 2 works in normal status, iAMT 8.0 function is enabled.

Using a suitable RJ-45 cable, you can connect the RCX-1000 system to a computer or to any other devices with Ethernet connection, for example, a hub or a switch. Moreover, both LAN 1 and LAN 2 support "Wake" on LAN and pre-boot functions. The pinouts of LAN 1 and LAN 2 are listed in the following chart :

Pin No.	10/100 Mbps	1000Mbps
1	E_TX+	MDI0_P
2	E_TX-	MDI0_N
3	E_RX+	MDI1_P
4	-----	MDI2_P
5	-----	MDI2_N
6	E_RX-	MDI1_N
7	-----	MDI3_P
8	-----	MDI3_N

Each LAN port is supported by a standard RJ-45 connector with LED indicators to present active/link/speed statuses of the connection.

The LED indicator on the right bottom corner becomes solid green when the cable is properly connected to a 100Mbps Ethernet network; it becomes solid orange when the cable is properly connected to a 1000Mbps Ethernet network. The left LED will keep blinking off when Ethernet data packets are being transmitted or received.

LED Location	LED Color	10Mbps	100Mbps	1000Mbps
Right	Green/ Orange	Off	Solid Green	Solid Orange
Left	Yellow	Blinking Yellow	Blinking Yellow	Blinking Yellow

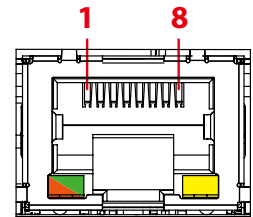

2.2.9 Audio Connector

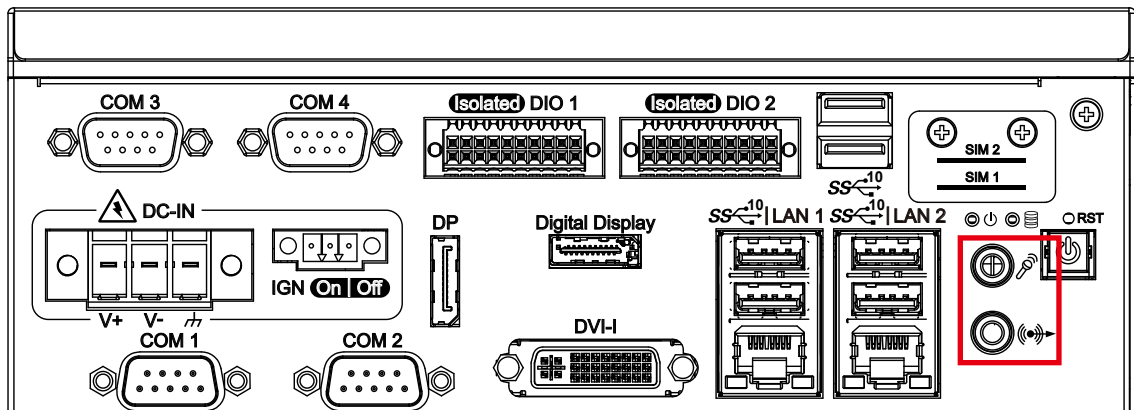

There are two audio connectors, mic-in and line-out, on the front side of RCX-1000. Onboard Realtek ALC888S-VD audio codec supports 7.1 channel HD audio and fully complies with Intel® High Definition Audio (Azalia) specifications.

To utilize the audio function on the Windows platform, you need to install corresponding drivers for both Intel® C246 chipset and Realtek ALC888S-VD codec. Please refer to chapter four for more details on driver installation.

2.2.10 Front-access SSD/HDD Tray

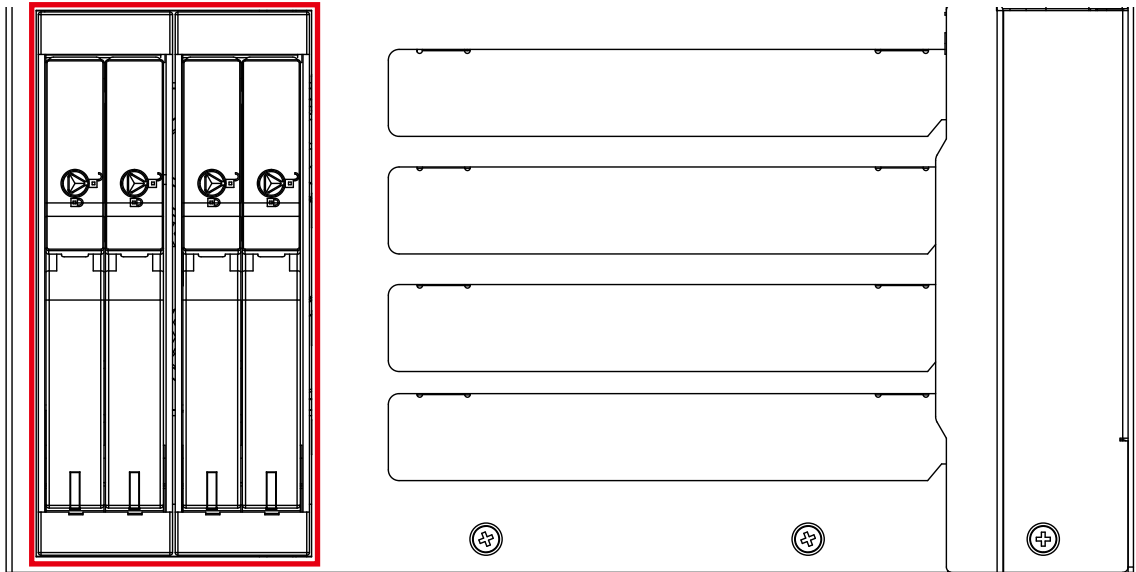

There are four front-access 2.5" SSD/HDD trays on the front side of RCX-1000. Press the trigger to open the SSD/HDD tray which has up to 8TB available.

2.2.11 Power Terminal Block

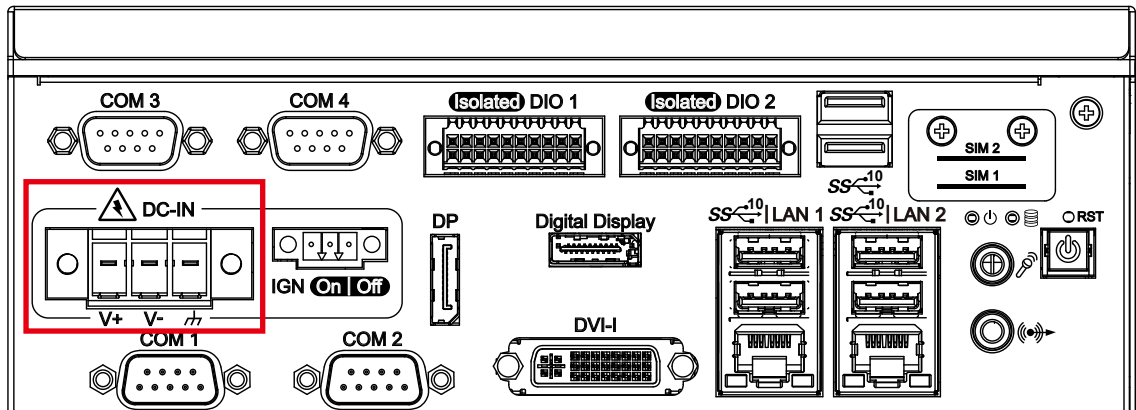

RCX-1000 supports 6V to 36V DC power input.

RCX-1000-12 only supports 12V DC power input.

Pin No.	Definition
1	Earth GND
2	V-
3	V+

2.2.12 Remote Power On/Off Switch

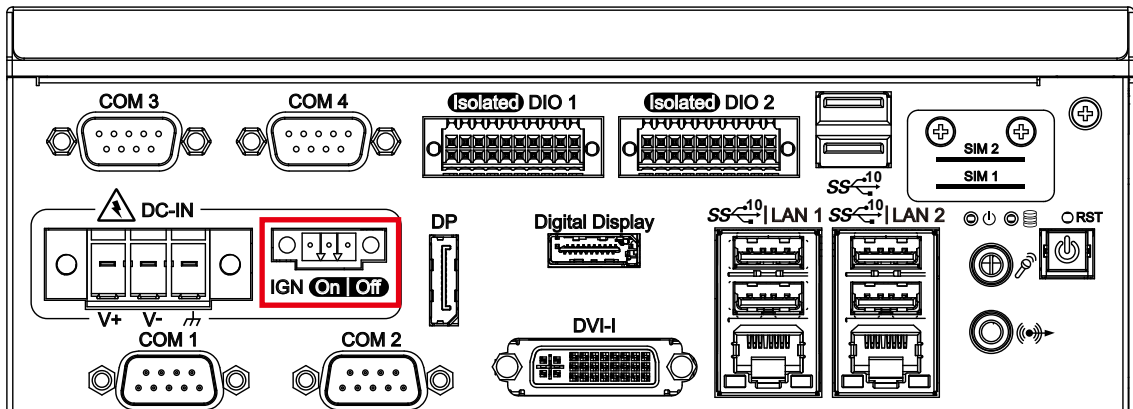

It is a 2-pin power-on/power-off switch through Phoenix Contact terminal block. You could turn on or off the system power by using this contact. This terminal block supports dual function on soft power-on/power-off (instant off or delay four seconds), and suspend mode.

Pin No.	Definition
1	IGNITION
2	SW+
3	SW-

2.2.13 Isolated DIO

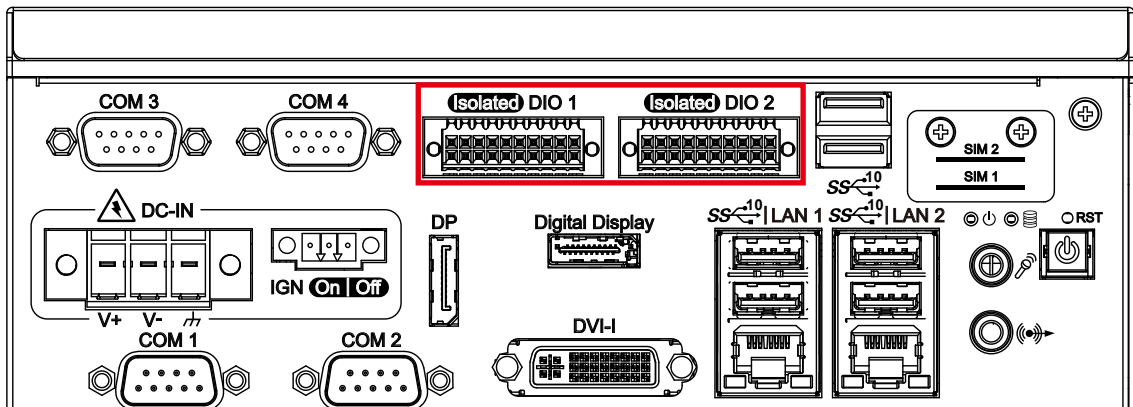

There are two 16-bit (8-bit DI, 8-bit DO) connectors on the rear side. DI/DIO support NPN (sink) and PNP (Source) mode, Each DI channel is equipped with a photocoupler and each DO with an isolator chip for isolated protection. Both are configured by a Jumper for each DIO connector.

DO Safety-Related Certifications :

- 4242-VPK Basic Isolation per DIN V VDE V 0884-10 and DIN EN 61010-1
- 3-KVRMS Isolation for 1 minute per UL 1577
- CSA Component Acceptance Notice 5A, IEC 60950-1 and IEC 61010-1 End Equipment Standards
- GB4943.1-2011 CQC Certified

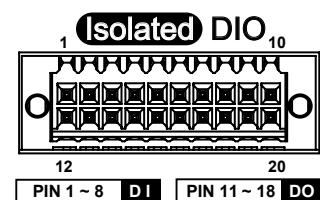

DIO1 Connectors pin out :

DIO	Pin No.	Definition	Function
DIO 1	1	INPUT 0	SIO_GPI80
	2	INPUT 1	SIO_GPI81
	3	INPUT 2	SIO_GPI82
	4	INPUT 3	SIO_GPI83
	5	INPUT 4	SIO_GPI84
	6	INPUT 5	SIO_GPI85
	7	INPUT 6	SIO_GPI86
	8	INPUT 7	SIO_GPI87
	9	+VDI_COM1	
	10	GND_ISO_DIO1	
	11	OUTPUT 0	SIO_GPO70
	12	OUTPUT 1	SIO_GPO71
	13	OUTPUT 2	SIO_GPO72
	14	OUTPUT 3	SIO_GPO73
	15	OUTPUT 4	SIO_GPO74
	16	OUTPUT 5	SIO_GPO75
	17	OUTPUT 6	SIO_GPO76
	18	OUTPUT 7	SIO_GPO77
	19	GND_ISO_DIO1	
	20	External 6-40VDC (NPN) External 6-48VDC (PNP)	

DIO2 Connectors pin out :

DIO	Pin No.	Definition	Function
DIO 2	1	INPUT 8	SIO_GPI0
	2	INPUT 9	SIO_GPI1
	3	INPUT 10	SIO_GPI2
	4	INPUT 11	SIO_GPI3
	5	INPUT 12	SIO_GPI4
	6	INPUT 13	SIO_GPI5
	7	INPUT 14	SIO_GPI6
	8	INPUT 15	SIO_GPI7
	9	+VDI_COM2	
	10	GND_ISO_DIO2	
	11	OUTPUT 8	SIO_GPO0
	12	OUTPUT 9	SIO_GPO1
	13	OUTPUT 10	SIO_GPO2
	14	OUTPUT 11	SIO_GPO3
	15	OUTPUT 12	SIO_GPO4
	16	OUTPUT 13	SIO_GPO5
	17	OUTPUT 14	SIO_GPO6
	18	OUTPUT 15	SIO_GPO7
	19	GND_ISO_DIO2	
	20	External 6-40VDC (NPN) External 6-48VDC (PNP)	

DI reference circuit :

Sink Mode (NPN)

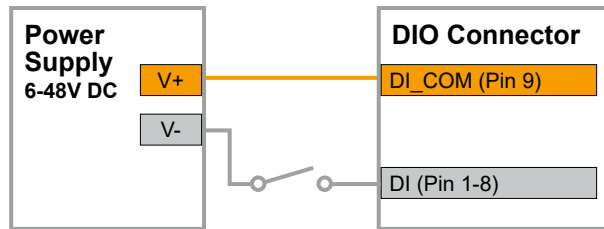

Source Mode (PNP)

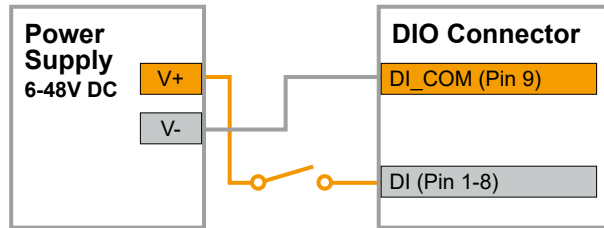

DO reference circuit :

Sink Mode (NPN, Default)

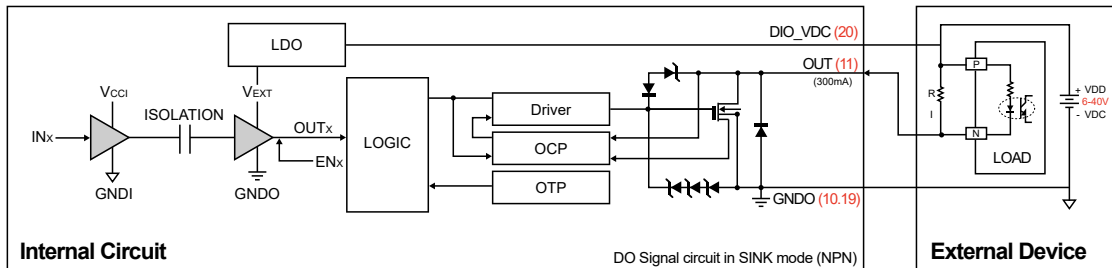

Source (PNP)

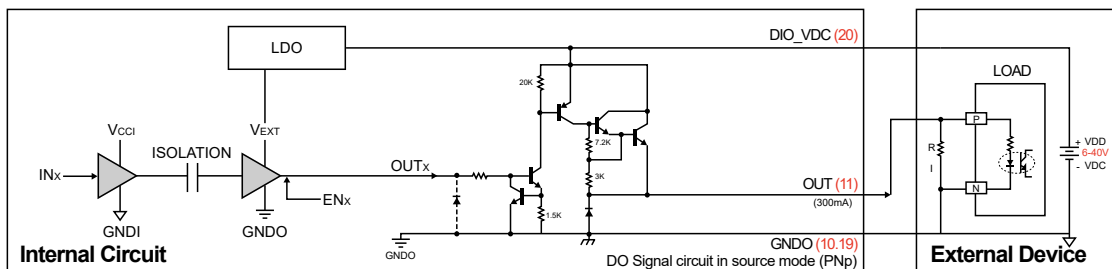

2.2.14 Serial Port COM

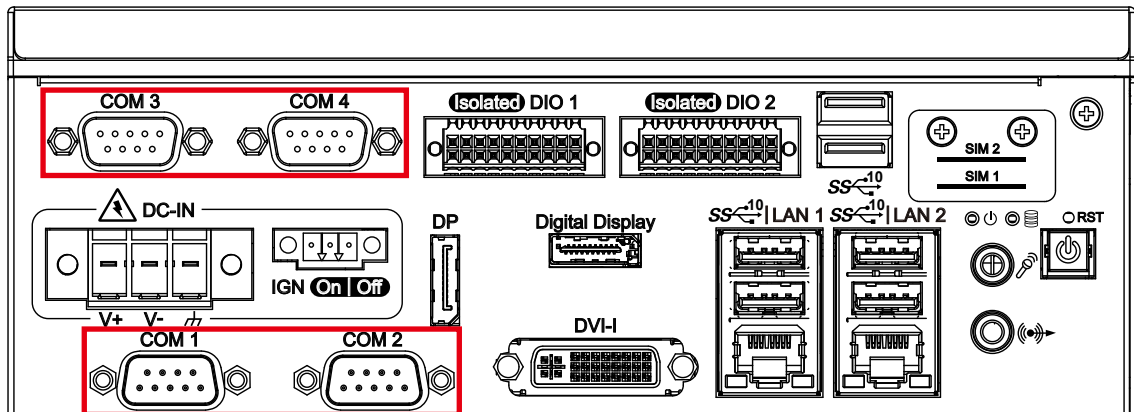

Serial port can be configured for RS-232, RS-422, or RS-485 with auto flow control communication. The default definition is RS-232, but if you want to change to RS-422 or RS-485, you can find the settings in BIOS.

BIOS Setting	Function
COM 1	RS-232
COM 2	RS-422 (5-wire)
COM 3	RS-422 (9-wire)
COM 4	RS-485
COM 4	RS-485 w/z auto-flow control

The pin assignments are listed in the table as follows :

Serial Port	Pin No.	RS-232	RS-422 (5-wire)	RS-422 (9-wire)	RS-485 (3-wire)
1, 2 3, 4	1	DCD	TXD-	TXD-	DATA-
	2	RXD	TXD+	TXD+	DATA+
	3	TXD	RXD+	RXD+	-----
	4	DTR	RXD-	RXD-	-----
	5	GND	GND	GND	GND
	6	DSR	-----	RTS-	-----
	7	RTS	-----	RTS+	-----
	8	CTS	-----	CTS+	-----
	9	RI	-----	CTS-	-----

2.3 Main Board Expansion Connectors

2.3.1 Front View of RCX-1000 Main Board With Connector Location

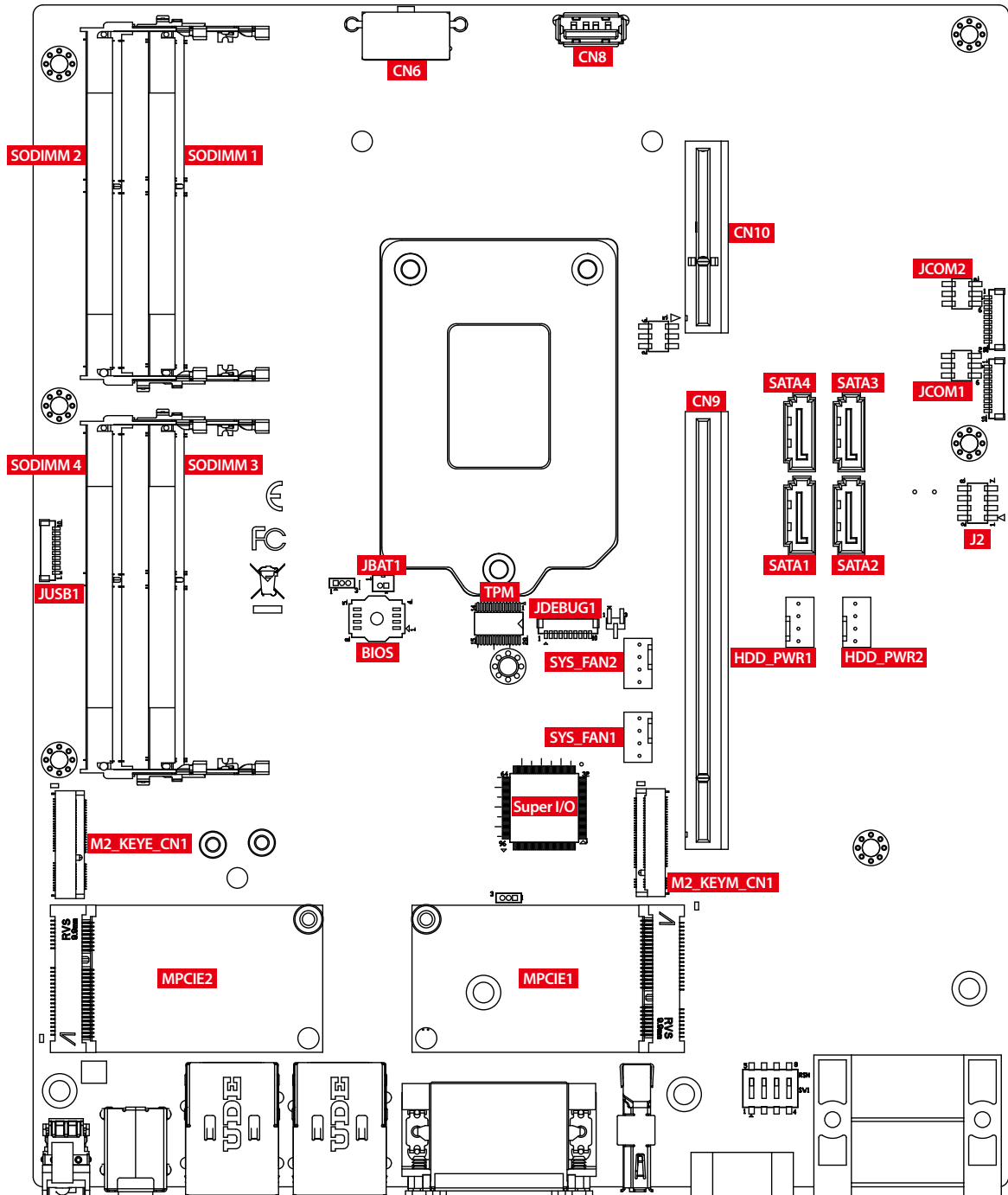

2.3.2 Rear View of RCX-1000 Main Board With Connector Location

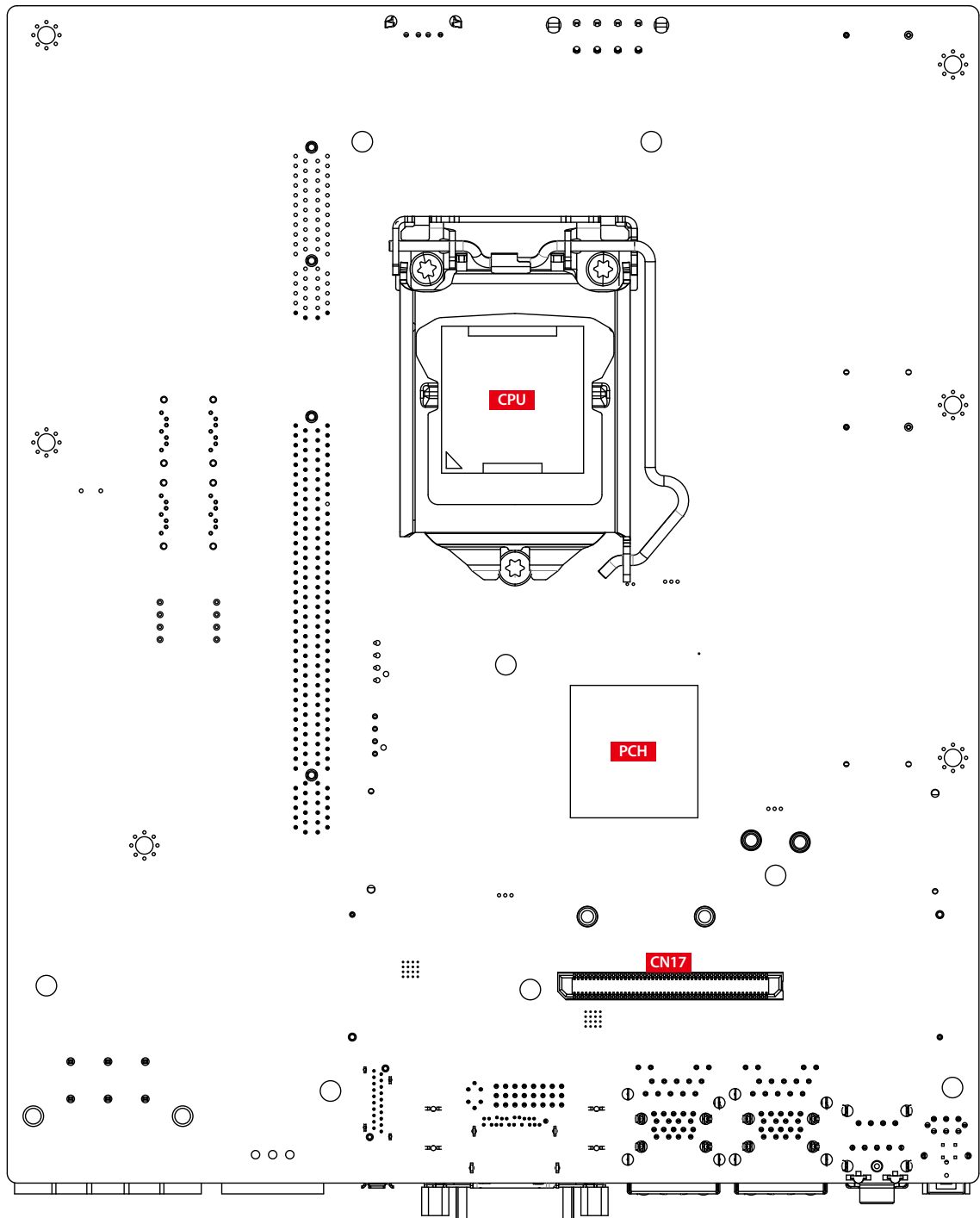

2.3.3 SYS_FAN1, SYS_FAN2

The fan power connector is for additional thermal requirements. The pin assignments of SYS_FAN1 and SYS_FAN2 are listed in the following table :

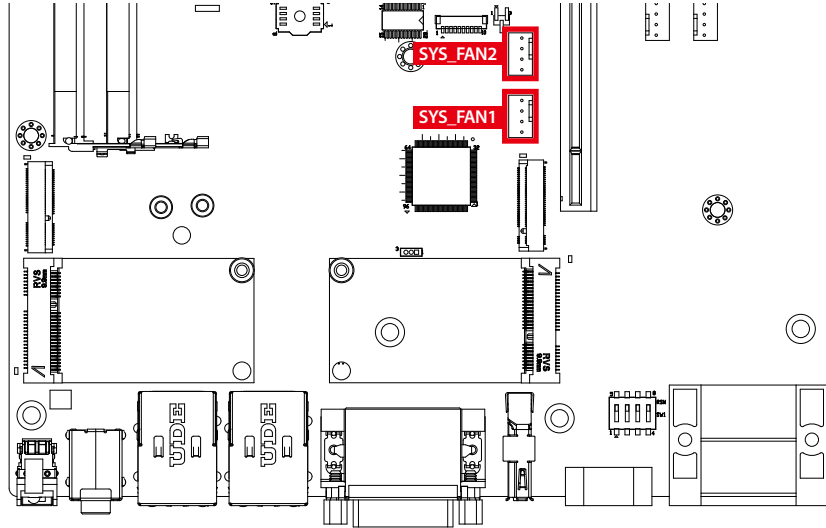

Pin No.	Definition	Pin No.	Definition
1	GND	3	Fan speed sensor
2	+12V (up to 2A)	4	Fan PWM

2.3.4 JBAT1 : Battery

The RCX-1000's real-time clock is powered by a lithium battery. It is equipped with Panasonic BR2032 190mAh lithium battery. It is recommended that you do not replace the lithium battery on your own. If the battery needs to be changed, please contact the Vecow RMA service team.

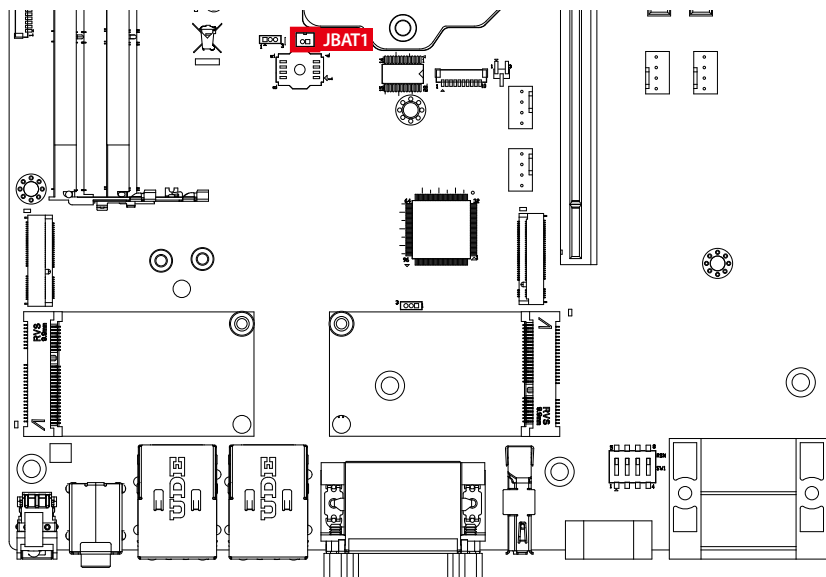

Pin No.	Definition	Pin No.	Definition
1	GND	2	+3V_BAT

2.3.5 CN10 : One PCIe x4 Slot (PCH)

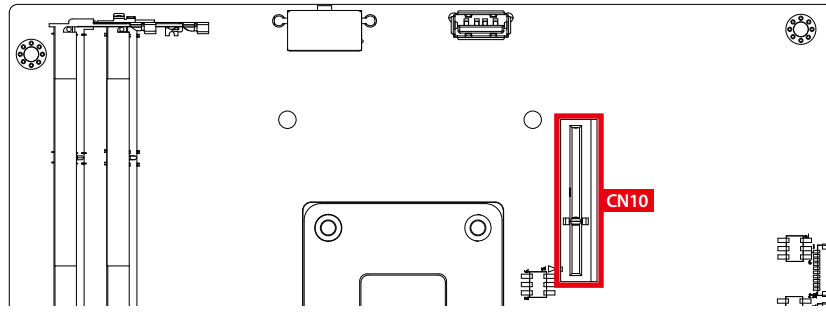

The pin assignments of CN10 are listed in the following table :

Pin No.	Definition	Pin No.	Definition
A1	Reserved	B1	+V12S
A2	+V12S	B2	+V12S
A3	+V12S	B3	+V12S
A4	GND	B4	GND
A5	CLKOUT_100M_X4_P2	B5	SM_SLOT_CLK
A6	CLKOUT_100M_X4_N2	B6	SM_SLOT_DAT
A7	CLKOUT_100M_X4_P3	B7	GND
A8	CLKOUT_100M_X4_N3	B8	+V3.3S
A9	+V3.3S	B9	Reserved
A10	+V3.3S	B10	+V3.3A
A11	PLTRST_PCIE#	B11	WAKE#
A12	GND	B12	Reserved
A13	CLKOUT_100M_X4_P0	B13	GND
A14	CLKOUT_100M_X4_N0	B14	PCIE_TXP21
A15	GND	B15	PCIE_TXN21
A16	PCIE_RXP21	B16	GND
A17	PCIE_RXN21	B17	Reserved
A18	GND	B18	GND
A19	Reserved	B19	PCIE_TXP22
A20	GND	B20	PCIE_TXN22
A21	PCIE_RXP22	B21	GND
A22	PCIE_RXN22	B22	GND
A23	GND	B23	PCIE_TXP23
A24	GND	B24	PCIE_TXN23
A25	PCIE_RXP23	B25	GND
A26	PCIE_RXN23	B26	GND
A27	GND	B27	PCIE_TXP24
A28	GND	B28	PCIE_TXN24
A29	PCIE_RXP24	B29	GND
A30	PCIE_RXN24	B30	CLKOUT_100M_X4_P1
A31	GND	B31	CLKOUT_100M_X4_N1
A32	Reserved	B32	GND

2.3.6 CN9 : One PCIe x16 Slot (CPU)

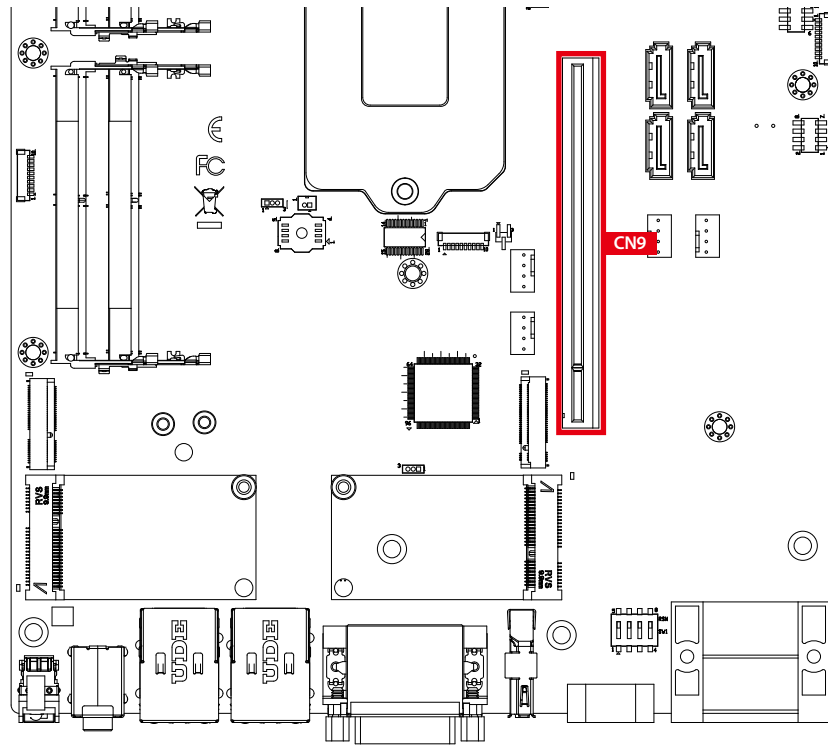

Pin No.	Definition	Pin No.	Definition
A1	Reserved	B1	+V12S
A2	+V12S	B2	+V12S
A3	+V12S	B3	+V12S
A4	GND	B4	GND
A5	CLKOUT_100M_X16_P2	B5	SM_SLOT_CLK
A6	CLKOUT_100M_X16_N2	B6	SM_SLOT_DAT
A7	USB_P8_DP	B7	GND
A8	USB_P8_DN	B8	+V3.3S
A9	+V3.3S	B9	GND
A10	+V3.3S	B10	+V3.3A
A11	PLTRST_PCIE#	B11	WAKE#
A12	GND	B12	Reserved
A13	CLKOUT_100M_X16_P0	B13	GND
A14	CLKOUT_100M_X16_N0	B14	PEG_TXP_0
A15	GND	B15	PEG_TXN_0
A16	PEG_RXP_0	B16	GND
A17	PEG_RXN_0	B17	Reserved

Pin No.	Definition	Pin No.	Definition
A18	GND	B18	GND
A19	Reserved	B19	PEG_TXP_1
A20	GND	B20	PEG_TXN_1
A21	PEG_RXP_1	B21	GND
A22	PEG_RXN_1	B22	GND
A23	GND	B23	PEG_TXP_2
A24	GND	B24	PEG_TXN_2
A25	PEG_RXP_2	B25	GND
A26	PEG_RXN_2	B26	GND
A27	GND	B27	PEG_TXP_3
A28	GND	B28	PEG_TXN_3
A29	PEG_RXP_3	B29	GND
A30	PEG_RXN_3	B30	PCIE_RXP7
A31	GND	B31	PCIE_RXN7
A32	CLKOUT_100M_X16_P1	B32	GND
A33	CLKOUT_100M_X16_N1	B33	PEG_TXP_4
A34	GND	B34	PEG_TXN_4
A35	PEG_RXP_4	B35	GND
A36	PEG_RXN_4	B36	GND
A37	GND	B37	PEG_TXP_5
A38	GND	B38	PEG_TXN_5
A39	PEG_RXP_5	B39	GND
A40	PEG_RXN_5	B40	GND
A41	GND	B41	PEG_TXP_6
A42	GND	B42	PEG_TXN_6
A43	PEG_RXP_6	B43	GND
A44	PEG_RXN_6	B44	GND
A45	GND	B45	PEG_TXP_7
A46	GND	B46	PEG_TXN_7
A47	PEG_RXP_7	B47	GND
A48	PEG_RXN_7	B48	Reserved
A49	GND	B49	GND
A50	Reserved	B50	PEG_TXP_8
A51	GND	B51	PEG_TXN_8

Pin No.	Definition	Pin No.	Definition
A52	PEG_RXP_8	B52	GND
A53	PEG_RXN_8	B53	GND
A54	GND	B54	PEG_TXP_9
A55	GND	B55	PEG_TXN_9
A56	PEG_RXP_9	B56	GND
A57	PEG_RXN_9	B57	GND
A58	GND	B58	PEG_TXP_10
A59	GND	B59	PEG_TXN_10
A60	PEG_RXP_10	B60	GND
A61	PEG_RXN_10	B61	GND
A62	GND	B62	PEG_TXP_11
A63	GND	B63	PEG_TXN_11
A64	PEG_RXP_11	B64	GND
A65	PEG_RXN_11	B65	GND
A66	GND	B66	PEG_TXP_12
A67	GND	B67	PEG_TXN_12
A68	PEG_RXP_12	B68	GND
A69	PEG_RXN_12	B69	GND
A70	GND	B70	PEG_TXP_13
A71	GND	B71	PEG_TXN_13
A72	PEG_RXP_13	B72	GND
A73	PEG_RXN_13	B73	GND
A74	GND	B74	PEG_TXP_14
A75	GND	B75	PEG_TXN_14
A76	PEG_RXP_14	B76	GND
A77	PEG_RXN_14	B77	GND
A78	GND	B78	PEG_TXP_15
A79	GND	B79	PEG_TXN_15
A80	PEG_RXP_15	B80	GND
A81	PEG_RXN_15	B81	PCIE_TXP7
A82	GND	B82	PCIE_TXN7

2.3.7 SATA1, SATA2, SATA3, SATA4 : SATA III Connector

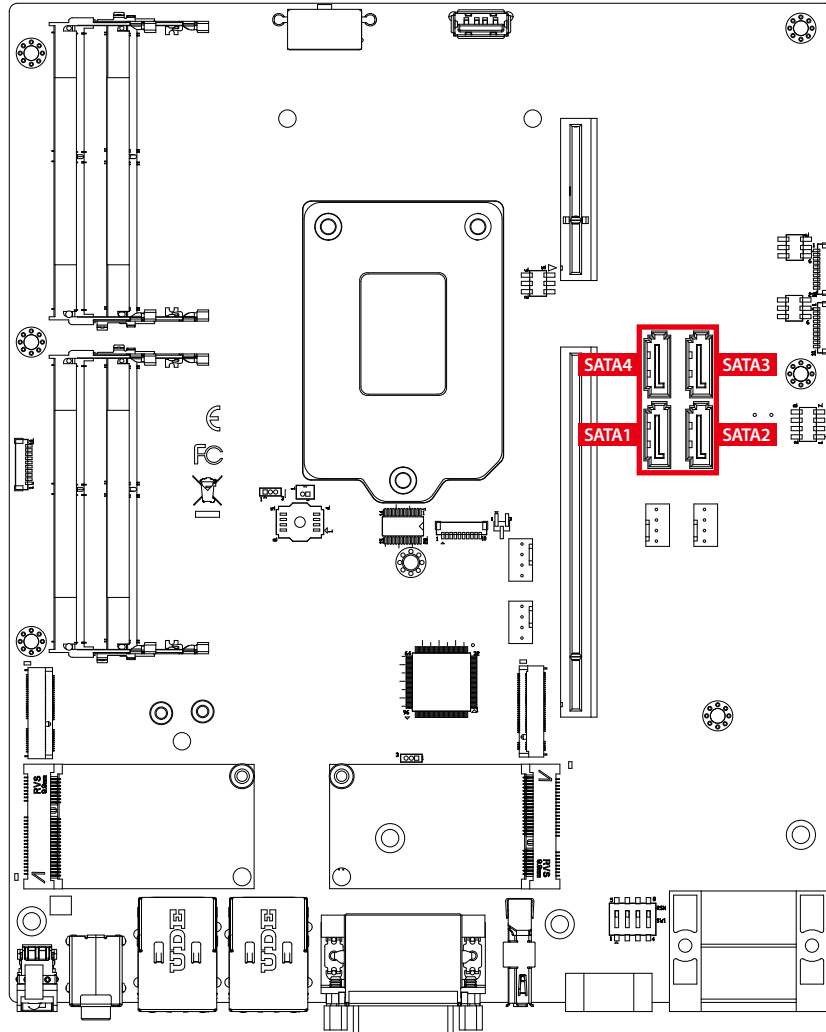

There are four onboard high performance Serial ATA IIIs (SATA III) on RCX-1000. It supports higher storage capacity with less cabling effort and smaller required space. The pin assignments of SATA1, SATA2, SATA3, and SATA4 are listed in the following table :

Pin No.	Definition	Pin No.	Definition
1	GND	2	TXP
3	TXN	4	GND
5	RXN	6	RXP
7	GND		

2.3.8 JDEBUG1 : LPC Port 80 Debug Port

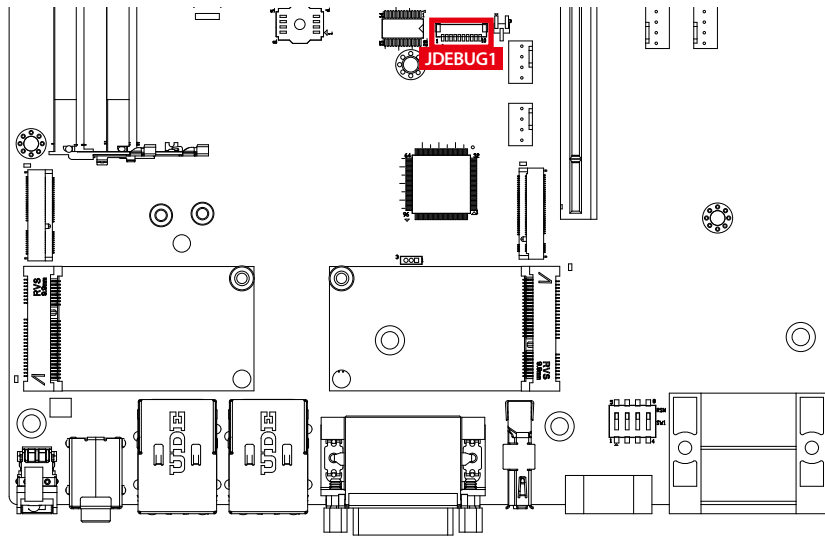

Pin No.	Definition	Pin No.	Definition
1	+V3.3S	2	LPC_SERIRQ
3	LPC_AD0	4	LPC_AD1
5	LPC_AD2	6	LPC_AD3
7	LPC_FRAME#	8	CLK_LPC_80
9	BUF_PLTRST_N_B	10	GND

2.3.9 HDD_PWR1, HDD_PWR2 : SATA Power Connector

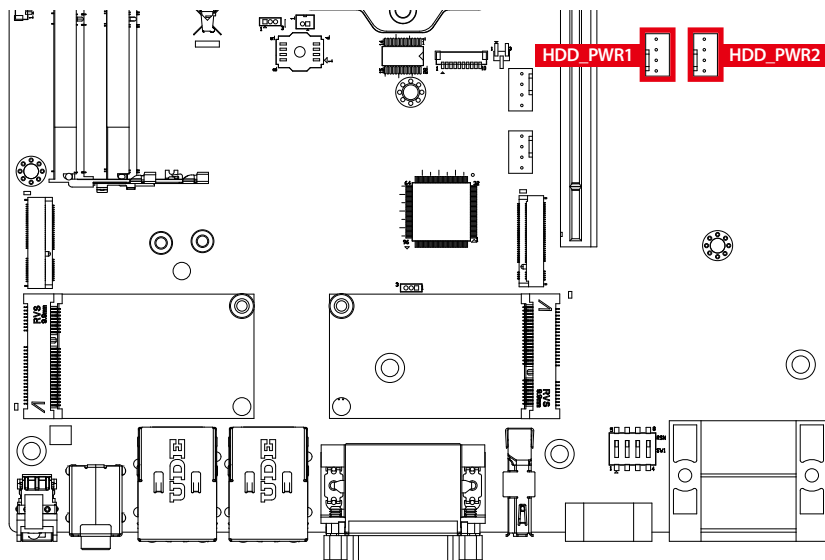

The RCX-1000 is also equipped with two SATA power connectors. It supports 5V (Up to 3A) and 12V (Up to 3A) currents to the hard drive or SSD. The pin assignments of HDD_PWR1 and HDD_PWR2 are listed in the following table :

Pin No.	Definition	Pin No.	Definition
1	+12V	2	GND
3	GND	4	+5V

2.3.10 CN8 : Internal USB 2.0 Port

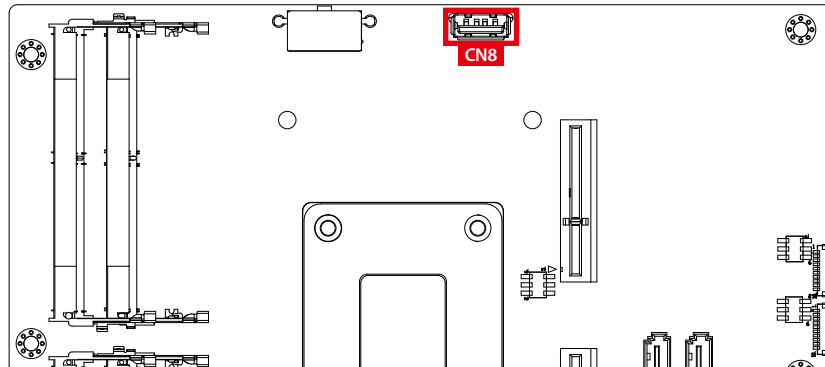

The USB 2.0 connections available support up to 480Mbps. It is also compliant with the requirements of high speed (HS), full speed (FS) and low speed (LS).

The pin assignments of CN8 are listed in the following table :

Pin No.	Definition	Pin No.	Definition
1	+V5_USB7_PWR	2	USB_D_11N
3	USB_D_11P	4	GND

2.3.11 JUSB1 : Internal Dual Port USB 2.0

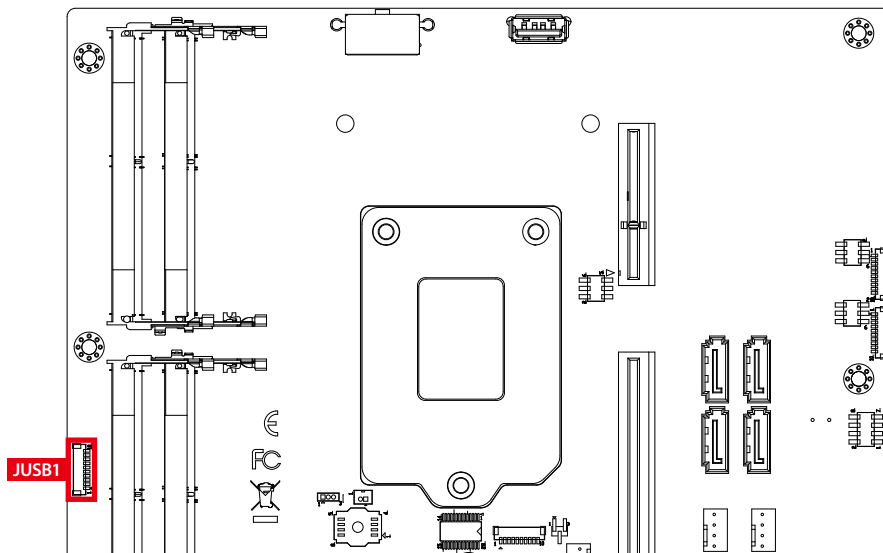

The RCX-1000 main board provides up to two expansion USB ports using plug-and-play for Dongle Key or LCD touch panel. The USB interface supports 480Mbps transfer rate complying with high speed USB specification Rev. 2.0. The USB ports are fuse protected.

The USB interface is accessed through one 1x10-pin JST 1.0mm connector. You will need an adapter cable if you use a standard USB connector. The adapter cable has a 1x10-pin connector on one end and a USB connector on the other.

The pin assignments of JUSB1 are listed in the following table :

Pin No.	Definition	Pin No.	Definition
1	+V5_USB8_PWR	2	+V5_USB8_PWR
3	+V5_USB8_PWR	4	USB_D_13N
5	USB_D_13P	6	USB_D_14N
7	USB_D_14P	8	GND
9	GND	10	GND

2.3.12 MPCIE1, MPCIE2 : Mini PCIe, mSATA

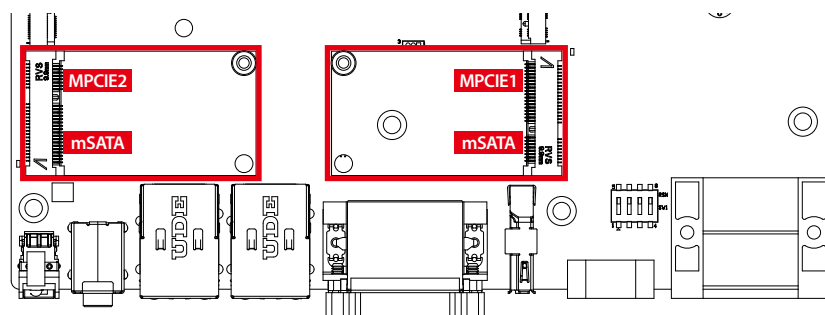

Both mSATA and mini PCIe share the same form factor and similar electrical pinout assignments on their connectors. There was no clear mechanism to distinguish if an mSATA drive or a Mini PCIe device is plugged into the socket until recently when SATA I/O issued an ECN change (ECN #045) to redefine pin-43 on mSATA connector as "no connect" instead of "return current path" (or GND).

When a mSATA drive is inserted, its pin-43 is "no connect", and the respective pin on the socket is being pulled-up to logic 1. When a mini PCIe device is inserted, its pin-43 forces the respective pin on the socket to ground, or logic 0.

The pin assignments of MPCIE1, MPCIE2 are listed in the following table :

Pin No.	Definition	Pin No.	Definition
51	Reserved	52	+3.3Vaux
49	Reserved	50	GND
47	Reserved	48	+1.5V
45	Reserved	46	Reserved
43	Status	44	Reserved

Pin No.	Definition	Pin No.	Definition
41	+3.3Vaux	42	Reserved
39	+3.3Vaux	40	GND
37	GND	38	USB_D+
35	GND	36	USB_D-
33	PETp0	34	GND
31	PETn0	32	SMB_DATA
29	GND	30	SMB_CLK
27	GND	28	+1.5V
25	PERp0	26	GND
23	PERn0	24	+3.3Vaux
21	GND	22	PERST#
19	Reserved	20	reserved
17	Reserved	18	GND
Mechanical Key			
15	GND	16	Reserved
13	REFCLK+	14	Reserved
11	REFCLK-	12	Reserved
9	GND	10	Reserved
7	CLKREQ#	8	Reserved
5	Reserved	6	1.5V
3	Reserved	4	GND
1	WAKE#	2	3.3Vaux

2.3.13 CN6 : 8Pin ATX Power Connector (Max 300W)

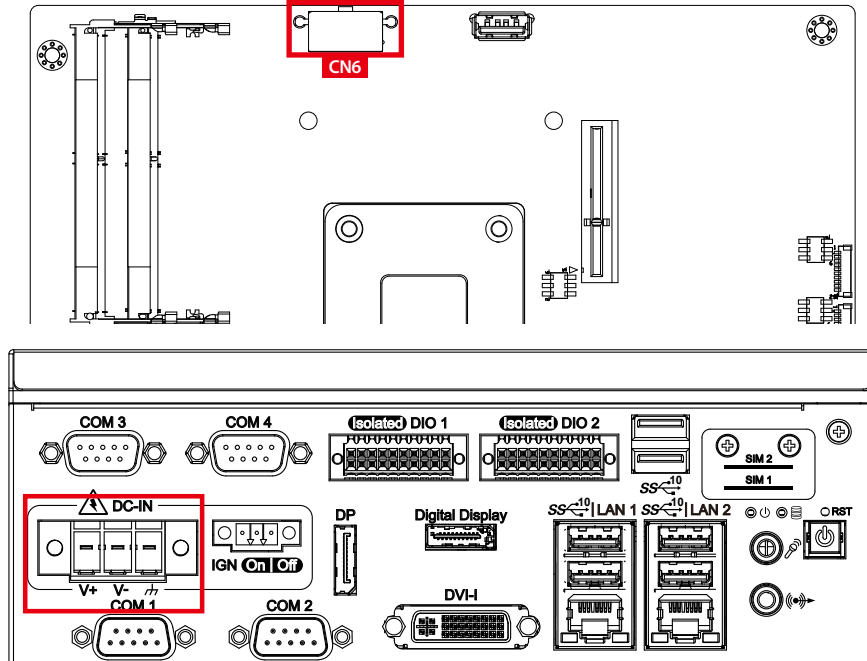

For RCX-1000-12, the power input voltage is 12V, CN6 supports 12V output.

For RCX-1000, the power input range is 24V to 36V. CN6 supports 12V output.

The pin assignments of CN6 are listed in the following table :

Pin No.	Definition	Pin No.	Definition
1	GND	2	GND
3	GND	4	GND
5	+V12_ATX	6	+V12_ATX
7	+V12_ATX	8	+V12_ATX

2.3.14 J2 : Miscellaneous Pin Header

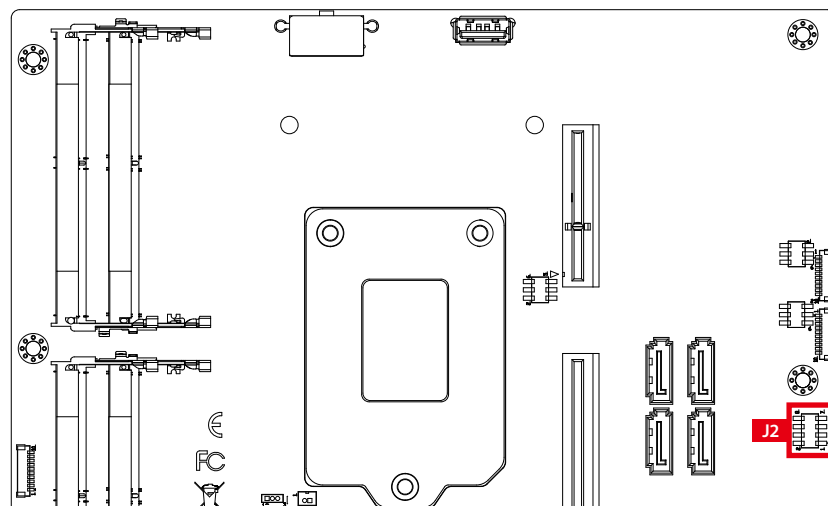

2.0mm 2x4p header

This pin header can be used as a backup for the following functions, hard drive LED indicator, reset button, power LED indicator, and power-on/off button.

The pin assignments of J2 are listed in the following table :

Group	Pin No.	Definition
HDD LED	1	HDD_LED_P
	3	HDD_LED_N
RESET BUTTON	5	FP_RST_BTN_N
	7	Ground
POWER LED	2	PWR_LED_P
	4	PWR_LED_N
POWER BUTTON	6	FP_PWR_BTN_IN
	8	Ground

2.3.15 SODIMM1, SODIMM2, SODIMM3, SODIMM4

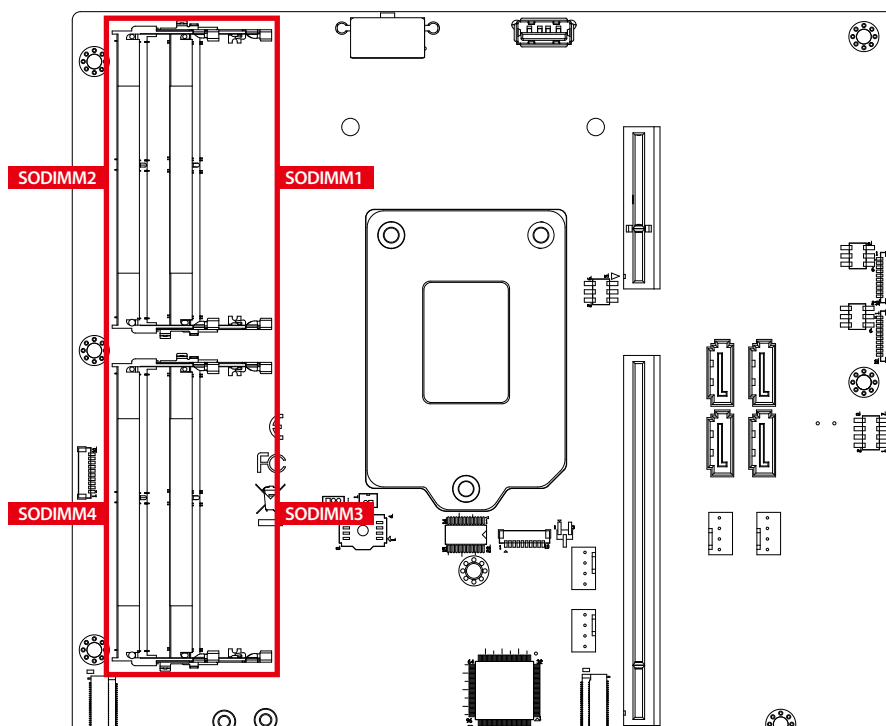

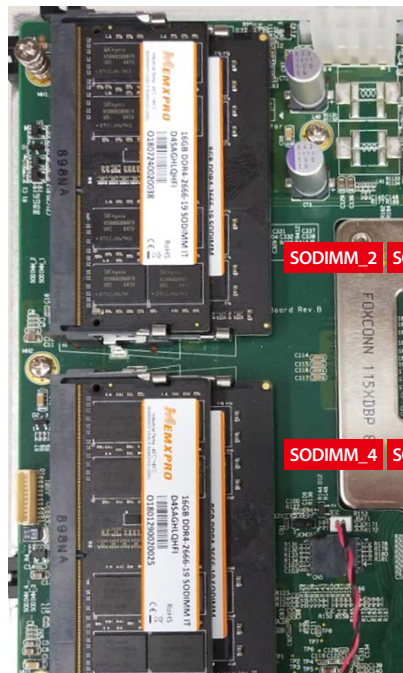
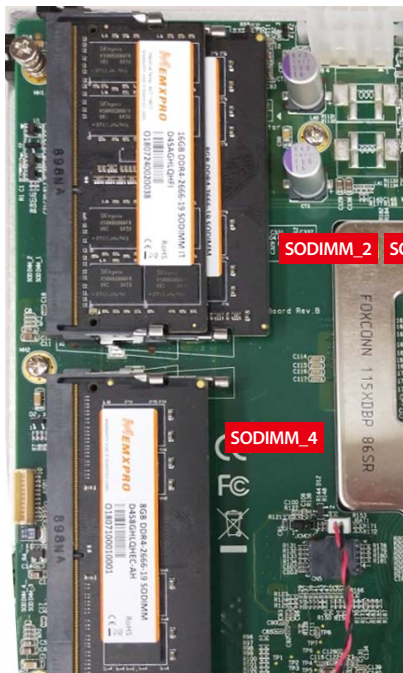
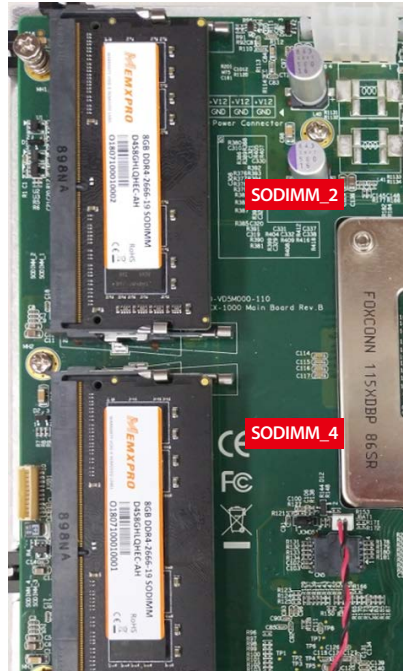

SODIMM Quantity	Location
1	SODIMM_2
2	SODIMM_2, SODIMM_4
3	SODIMM_2, SODIMM_4, SODIMM_1
4	SODIMM_2, SODIMM_4, SODIMM_1, SODIMM_3

2.3.16 M2_KEYE_CN1 : USB, PCIe2 support

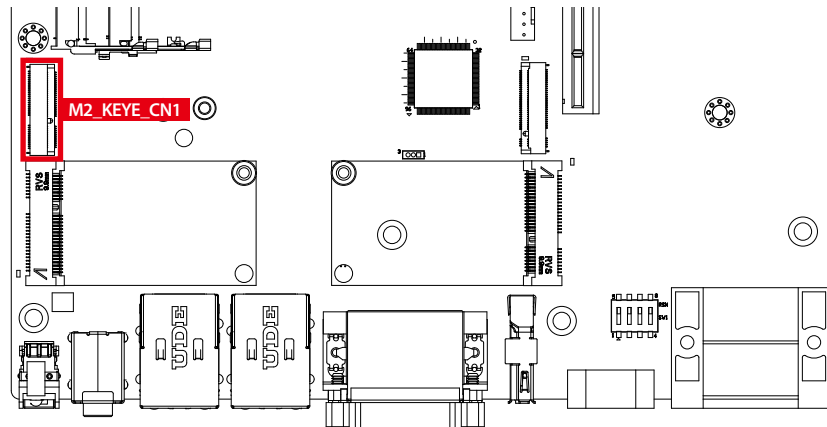

M.2 key E connector is suitable for applications that use wireless connectivity including Wi-Fi, Bluetooth, NFC or GNSS. Module card types include 1630, 2230 and 3030.

Pin Out :

Pin No.	Definition	Pin No.	Definition
74	3.3V	75	GND
72	3.3V	73	RESERVED/REFCLKn1
70	NC	71	RESERVED/REFCLKp1
68	NC	69	GND
66	NC	67	RESERVED/PETn1
64	NC	65	RESERVED/PETp1
62	ALERT# (O)(0/3.3V)	63	GND
60	12C_CLK (I)(0/3.3V)	61	RESERVED/PERn1
58	12C_DATA (I/O)(0/3.3V)	59	RESERVED/PERp1
56	NC	57	GND
54	NC	55	PEWAKE0# (I/O) (0/3.3V)
52	PERST0# (I)(0/3.3V)	53	CLKREQ0# (I/O) (0/3.3V)
50	NC	51	GND
48	NC	49	REFCLKn0
46	NC	47	REFCLKp0
44	NC	45	GND
42	NC	43	PETn0
40	NC	41	PETp0
38	NC	39	GND
36	NC	37	PERn0
34	NC	35	PERp0
32	NC	33	GND
	Module Key		Module Key
	Module Key		Module Key

Pin No.	Definition	Pin No.	Definition
	Module Key		Module Key
	Module Key		Module Key
22	NC	23	NC
20	NC	21	NC
18	GND	19	NC
16	NC	17	NC
14	NC	15	NC
12	NC	13	NC
10	NC	11	NC
8	NC	9	NC
6	LED1# (O)(od)	7	GND
4	3.3V	5	USB_D-
2	3.3V	3	USB_D+
		1	GND

2.3.17 M2_KEYM_CN1 : PCIe x4/SATA Support

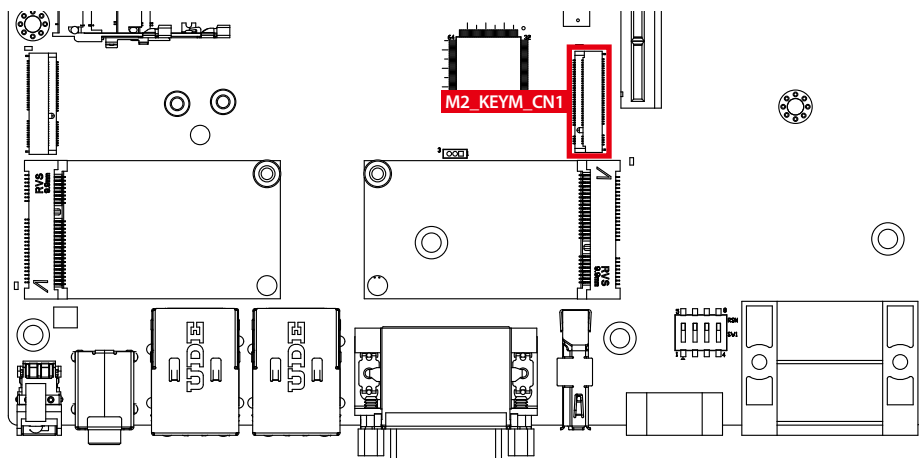

M.2 key M connector is suitable for applications that use Host I/Fs supported by either PCIe or SATA, or Solid State Storage Devices (SSD). Module card types include 2242, 2260, 2280

Pin Out :

Pin No.	Definition	Pin No.	Definition
74	3.3V	75	GND
72	3.3V	73	GND
70	3.3V	71	GND
68	SCUSCLK (3.2KHz)(O) (0/3.3V)	69	PEDET (NC-PCIe/GND- SATA)
	Connector Key	67	N/C

Pin No.	Definition	Pin No.	Definition
	Connector Key		Connector Key
	Connector Key		Connector Key
	Connector Key		Connector Key
58	N/C		Connector Key
56	N/C	57	GND
54	PEWAKE# (I/O)(O) (0/3.3V) or N/C	55	REFCLKp
52	CLKREQ# (I/O)(O)(0/3.3V) or N/C	53	REFCLKn
50	PERST# (I/O)(O)(0/3.3V) or N/C	51	GND
48	N/C	49	PETp0/SATA-A+
46	N/C	47	PETn0/SATA-A-
44	N/C	45	GND
42	N/C	43	PERp0/SATA-B-
40	N/C	41	PERp0/SATA-B+
38	DEVSLP (O)	39	GND
36	N/C	37	PETp1
34	N/C	35	PETn1
32	N/C	33	GND
30	N/C	31	PERp1
28	N/C	29	PERn1
26	N/C	27	GND
24	N/C	25	PETp2
22	N/C	23	PETn2
20	N/C	21	GND
18	3.3V	19	PERp2
16	3.3V	17	PERn2
14	3.3V	15	GND
12	3.3V	13	PETp3
10	DAS/DDS# (I/O)/LED1# (I) (0/3.3V)	11	PETn3
8	N/C	9	GND
6	N/C	7	PERp3
4	3.3V	5	PERn3
2	3.3V	3	GND
		1	GND

2.3.18 CN17 : IO Board Connector

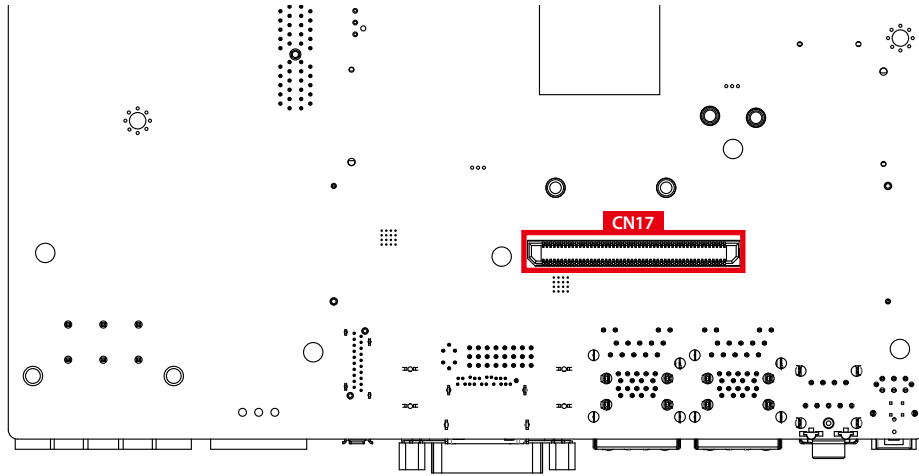

The pin assignments of CN17 are listed in the following table :
Pin Out :

Pin No.	Definition	Pin No.	Definition
1	UIM_PWR_1	2	UIM_PWR_2
3	UIM_DATA_1	4	UIM_DATA_2
5	UIM_CLK_1	6	UIM_CLK_2
7	UIM_RESET_1	8	UIM_RESET_2
9	UIM_VPP_1	10	UIM_VPP_2
11	SIO_GPI80	12	DIO2_GPI0
13	SIO_GPI81	14	DIO2_GPI1
15	SIO_GPI82	16	DIO2_GPI2
17	SIO_GPI83	18	DIO2_GPI3
19	SIO_GPI84	20	DIO2_GPI4
21	SIO_GPI85	22	DIO2_GPI5
23	SIO_GPI86	24	DIO2_GPI6
25	SIO_GPI87	26	DIO2_GPI7
27	SIO_GPO70	28	DIO2_GPO0
29	SIO_GPO71	30	DIO2_GPO1
31	SIO_GPO72	32	DIO2_GPO2
33	SIO_GPO73	34	DIO2_GPO3
35	SIO_GPO74	36	DIO2_GPO4
37	SIO_GPO75	38	DIO2_GPO5
39	SIO_GPO76	40	DIO2_GPO6

Pin No.	Definition	Pin No.	Definition
41	SIO_GPO77	42	DIO2_GPO7
43	GND	44	GND
45	UART3_DCD#	46	UART4_DCD#
47	UART3_RXD	48	UART4_RXD
49	UART3_TXD	50	UART4_TXD
51	UART3_DTR#	52	UART4_DTR#
53	UART3_DSR#	54	UART4_DSR#
55	UART3_RTS#	56	UART4_RTS#
57	UART3_CTS#	58	UART4_CTS#
59	UART3_RI#	60	UART4_RI#
61	UART3_MODE0	62	UART4_MODE0
63	UART3_MODE1	64	UART4_MODE1
65	UART3_MODE2	66	UART4_MODE2
67	SP338E_TERM_COM3	68	SP338E_TERM_COM4
69	+V3.3S	70	+V3.3S
71	+V3.3S	72	+V3.3S
73	GND	74	GND
75	SIO_GP60	76	SIO_GP47
77	SIO_GP61	78	SIO_GP62
79	GND	80	GND
81	USB3_PCH_RXN1	82	USB3_PCH_RXN2
83	USB3_PCH_RXP1	84	USB3_PCH_RXP2
85	GND	86	GND
87	USB3_PCH_TXN1	88	USB3_PCH_TXN2
89	USB3_PCH_TXP1	90	USB3_PCH_TXP2
91	GND	92	GND
93	USB_P1_DP	94	USB_P2_DP
95	USB_P1_DN	96	USB_P2_DN
97	+V5A	98	+V5A
99	+V5A	100	+V5A

2.4 Main Board Jumper Settings

2.4.1 Board top view of the system main board with jumper and deep switch

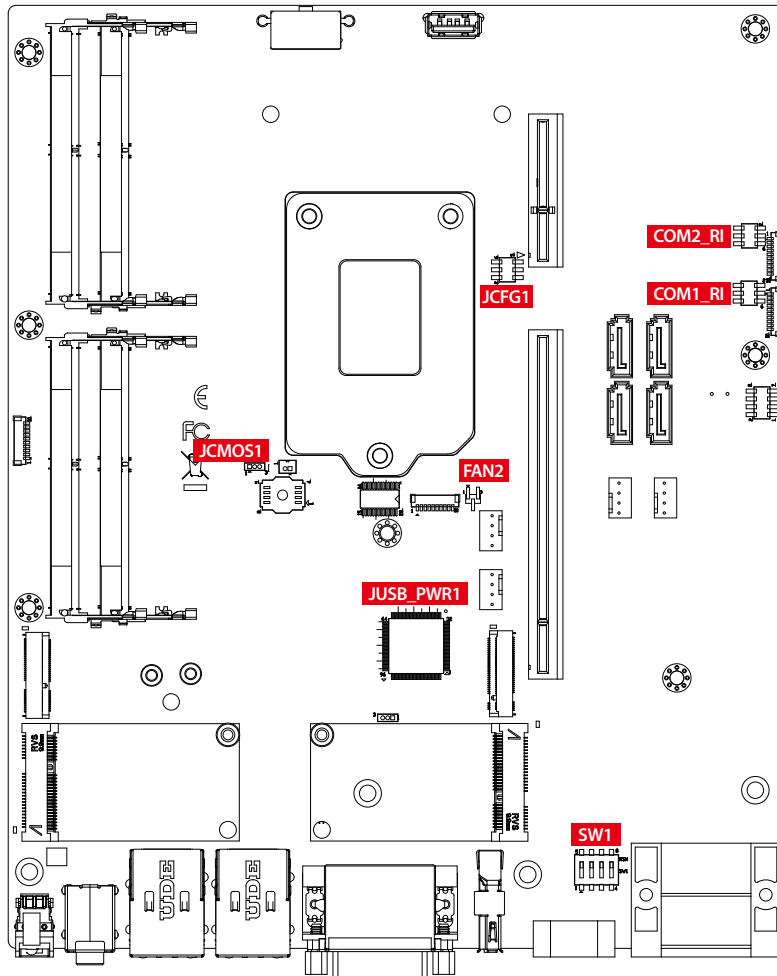

The figure below is the top view of the system main board. It shows the location of the jumpers and the switches.

You may configure your card to match the needs of your application by setting jumpers. A jumper is a metal bridge used to close an electric circuit. It consists of two metal pins and a small metal clip (often protected by a plastic cover) that slides over the pins to connect them. To "close" a jumper, you connect the pins with the clip. To "open" a jumper, you remove the clip. Sometimes a jumper will have three pins, labeled 1, 2 and 3. In this case you would connect either pins 1 and 2, or 2 and 3.

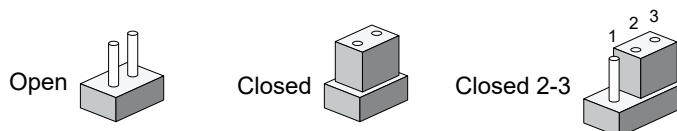

You may configure your card to match the needs of your application by DIP switch. As below show the deep switch on and off.

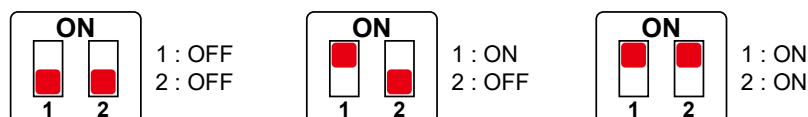

2.4.2 COM1_RI, COM2_RI

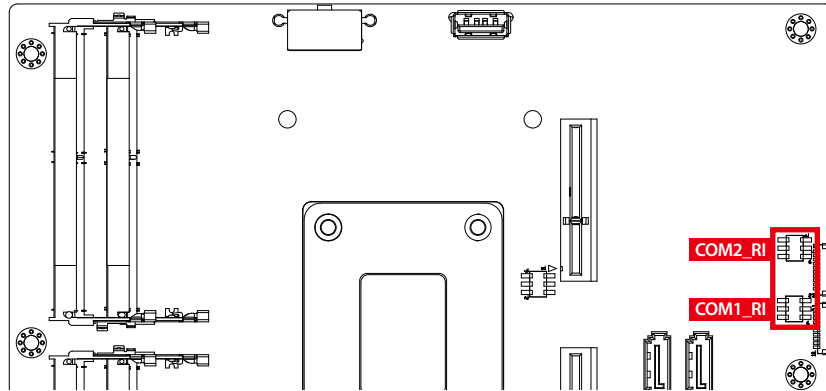

Pin Header	Pin No.	Definition
COM1_RI	1 - 2	+5V (1A max.)
	3 - 4	+12V (0.5A max.)
	5 - 6	RI (Default)
Pin Header	Pin No.	Definition
COM2_RI	1 - 2	+5V (1A max.)
	3 - 4	+12V (0.5A max.)
	5 - 6	RI (Default)

2.4.3 JP1 : CPU PCIe x 16 (CN9) Configuration

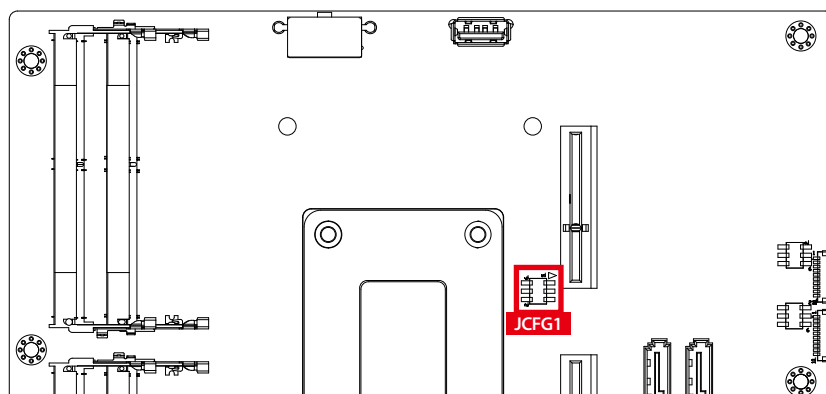

CPU PCIe x 16 (CN9) configuration table as follows :

PCIe Configuration	Header
1 x8, 2 x4	(3-5) (4-6)
2 x 8	(3-5) (2-4)
1 x16	(1-3) (2-4)

2.4.4 JP2 : Clear CMOS

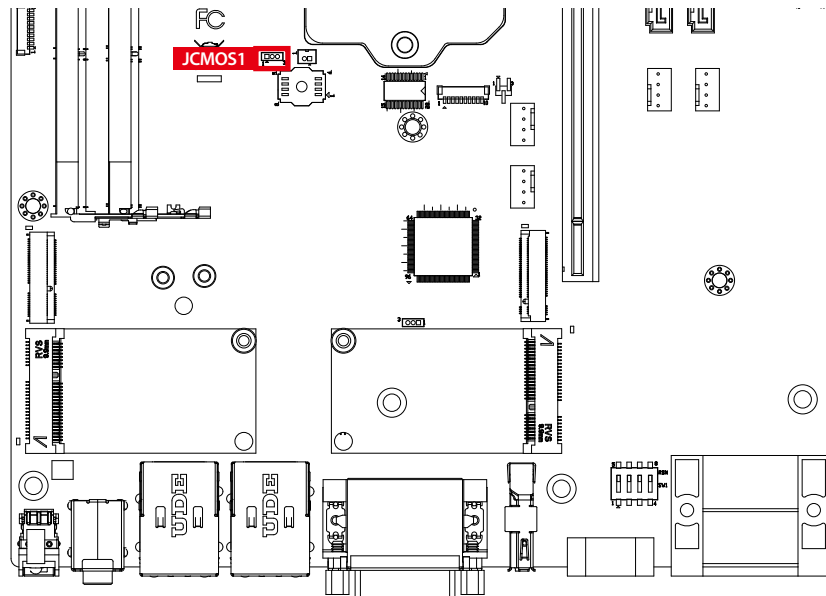

CMOS	Header
1-2	Normal (Default)
2-3	Clear CMOS

2.4.5 JUSB_PWR1 Pin Header : USB Wake Up

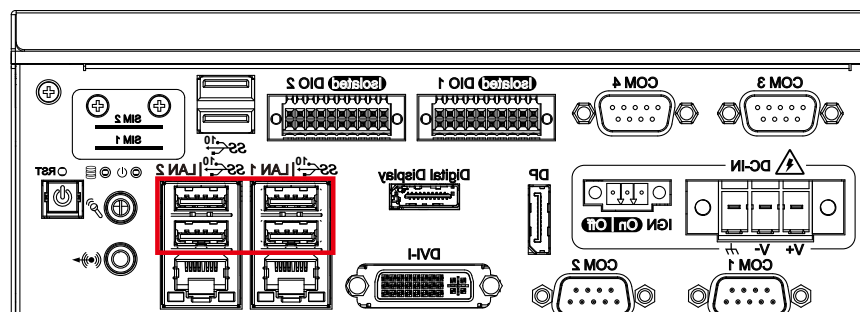
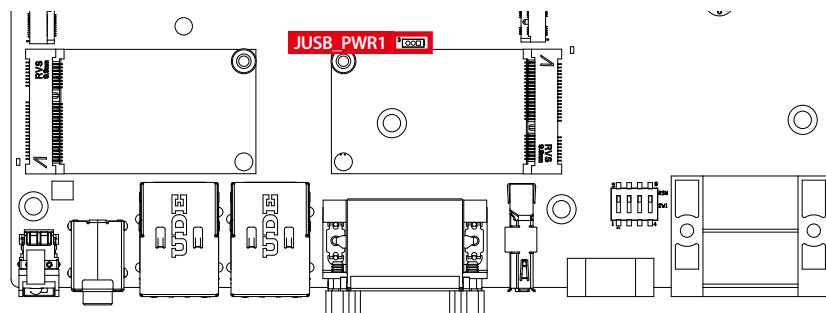

Pin No.	Definition
(1-2)	USB 3.0 and USB 2.0 Wake Up Enable (Default)
(2-3)	USB 3.0 and USB 2.0 Wake Up Disable

2.4.6 FAN2 Header

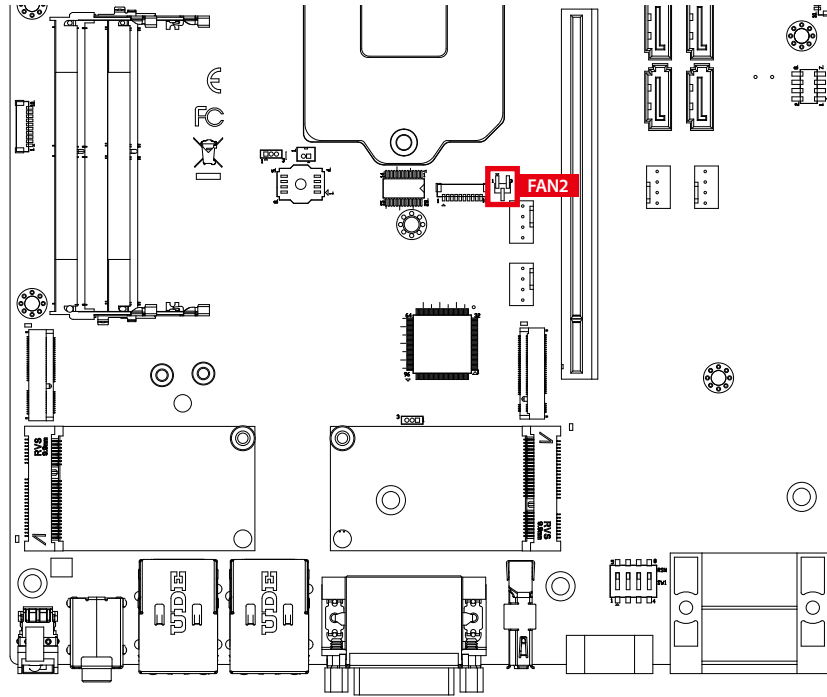

Pin No.	Definition
(1-2)	SYS_FAN2 : PCH PWM Control (Default)
(2-3)	SYS_FAN2 : Full Speed

2.5 Ignition Control

2.5.1 SW1 : Ignition Control



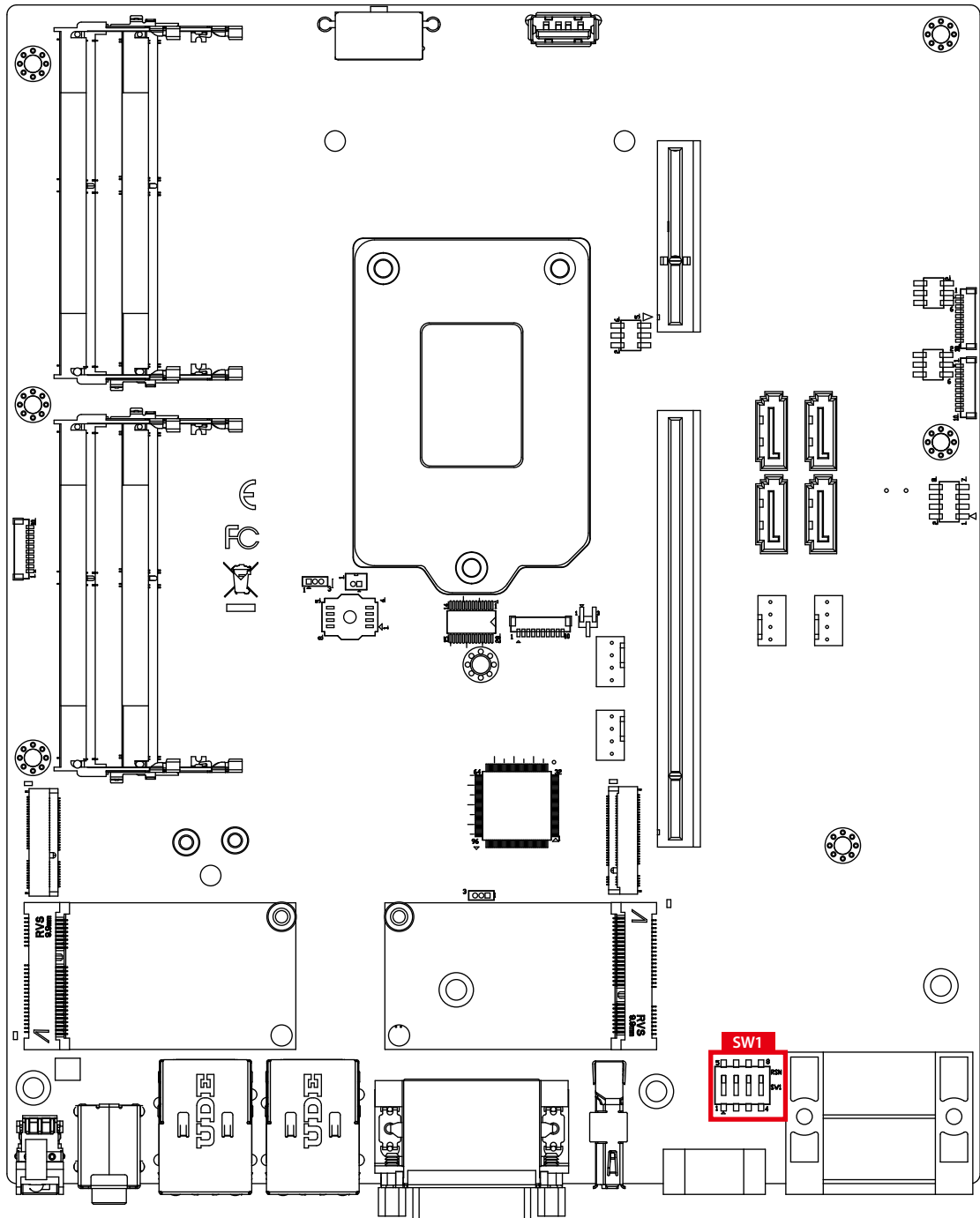







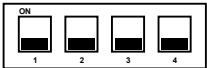





The RCX-1000 series provide ignition power control feature for in-vehicle applications. The built-in MCU monitors the ignition signal and turns on/off the system according to pre-defined on/off delay period.

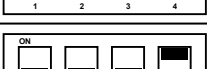

2.5.2 Adjust Ignition Control Modes

The RCX-1000 series provide sixteen modes of different power on/off delay periods adjustable via rotary switch. The default rotary switch is set to 0 in ATX/AT power mode.

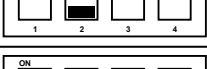
The modes are listed in the following table :

Deep Switch Position	Power on delay	Power off delay	Switch Position
0	ATX/AT mode (Default)		
1	No delay	No delay	
2	No delay	5 seconds	
3	No delay	10 seconds	
4	No delay	20 seconds	
5	5 seconds	30 seconds	
6	5 seconds	60 seconds	
7	5 seconds	90 seconds	
8	5 seconds	30 minutes	
9	5 seconds	1 hour	
A	10 seconds	2 hours	
B	10 seconds	4 hours	
C	10 seconds	6 hours	
D	10 seconds	8 hours	
E	10 seconds	12 hours	
F	10 seconds	24 hours	

2.5.3 Ignition Control Wiring

To activate ignition control, you need to provide IGN signal via the 3-pin pluggable terminal block located on the front panel. Please use the following pictures to find the general wiring configuration.



Pin No.	Definition
1	Ignition
2	SW+
3	SW-

For testing purpose, you can refer to the picture below to simulate ignition signal input which is controlled by a latching switch.

Note :

1. DC power source and IGN share the same ground.
2. RCX-1000 supports 6V to 36V wide range DC power input in ATX/AT mode. In Ignition mode, the input voltage is fixed to 12V/24V for car battery scenario.
3. For proper ignition control, the power button setting should be in "Power Down" mode.

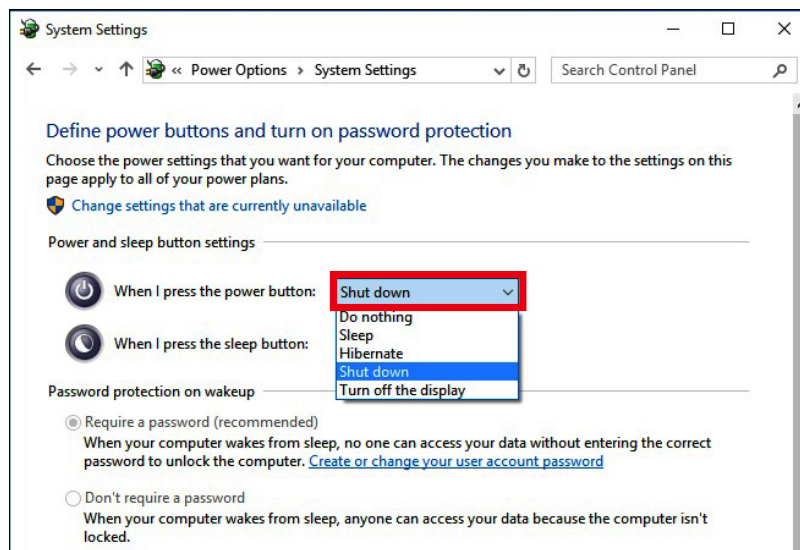

In Windows for example, you need to set "When I press the power button" to Shut down.

3

SYSTEM SETUP

3.1 How to open your RCX-1000

3.1.1 RCX-1400FR/1400F

Remove F-Head 6#-32 screws (circled in red) on the top cover. (12 places)



3.1.2 RCX-1400R/1400

Remove F-Head 6#-32 screws (circled in red) on the top cover. (9 places)



3.1.3 RCX-1200



3.2 Installing CPU

Step 1 Remove PH M3x6L screws (10 places)

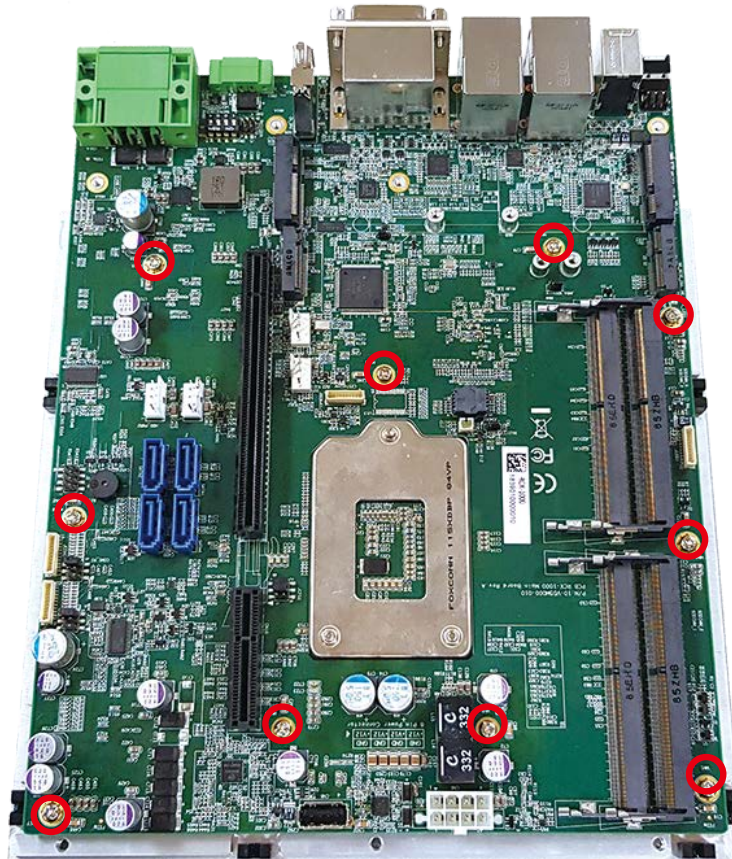

Step 2 Open the CPU slot.
(Other side)



Step 3 Push the slot key.

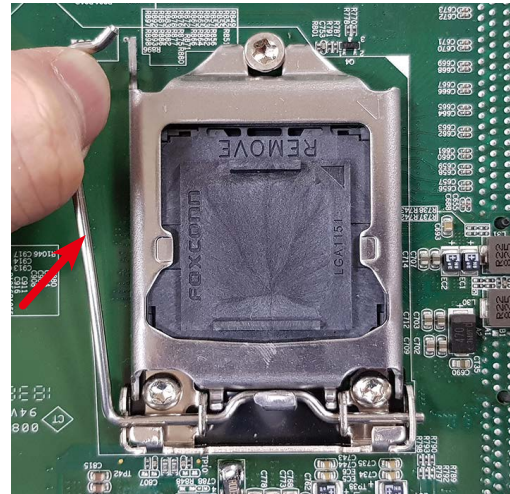

Step 4 Check CPU and CPU slot lock pin.



Step 5 Close the slot key and make sure the key is in the screw.



3.3 Installing DDR4 SO-DIMM Modules

Step 1 Install DDR4 RAM module into SO-DIMM slot.



Step 2 Make sure the RAM module is locked by the memory slots (red).



3.4 Installing Mini PCIe Card

Step 1 Install Mini PCIe card into the Mini PCIe slot.

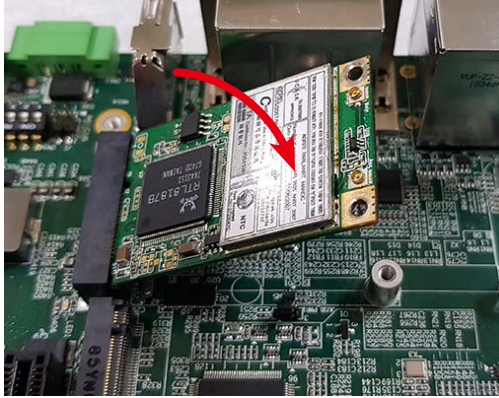

Step 2 Fasten one M2.5 screws.

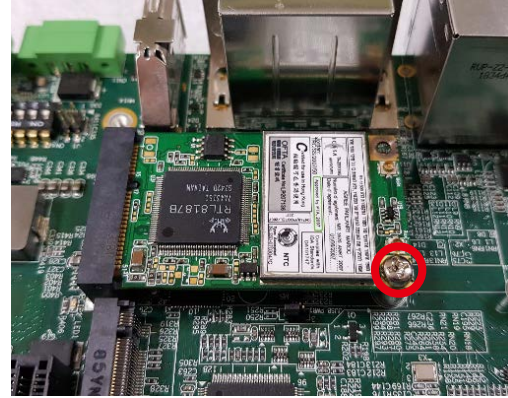

3.5 Installing M.2 (Key E/Key M)

Step 1 Install M.2 card into the Mini PCIe slot.



Step 2 Fasten one M3 screws.



3.6 Installing Antenna Cable

Step 1 Remove one rubber cork from the rear panel (pick the location you want).

RCX-1400FR/1400F/1400R/1400



RCX-1200



Step 2 Check antenna parts (cable and washers).

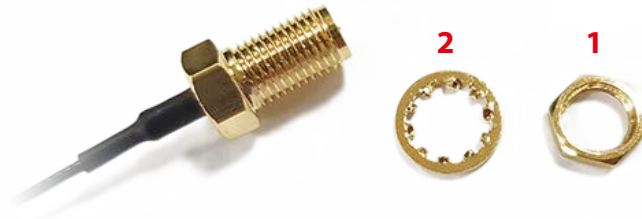

Step 3 Fasten washer 1, washer 2, and on Antenna cable connector



3.7 Installing Sim Card

Step 1 Remove SIM cover
(Remove 6#-32 x 5L screws).

Step 2 Install SIM card in the
marked yellow area.



3.8 Installing PCI/PCIe Card

RCX-1400F series : System designs will support 111.15 mm standard height, 312 mm maximum length (without the I/O bracket & power cable) expansion cards.

RCX-1400 series : System designs will support 111.15 mm standard height, 230 mm maximum length (without the I/O bracket & power cable) expansion cards.

RCX-1200 series : System designs will support 111.15 mm standard height, 220 mm maximum length (without the I/O bracket & power cable) expansion cards.

(*Based on the position of power connectors and the card sink/case design, not all expansion card within the maximum dimension can fit in to the system. Please consult the Vecow support team for confirmation.)

Step 1 Remove M3x5L screws and PCI bracket.



Step 2 Install the PCI/PCIe Card and lock it in place.

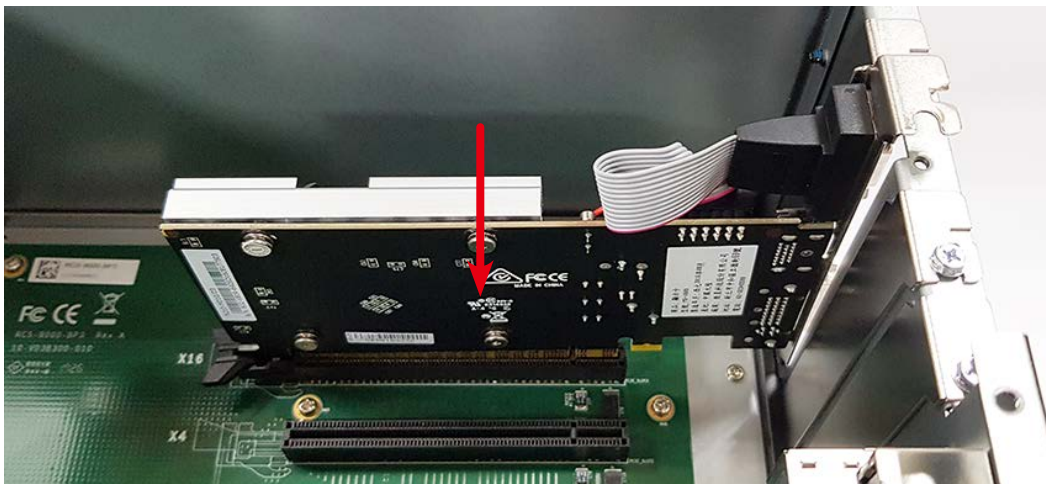

Step 3 Fasten one M3x5L screws.



Notice : For RCX-1400FR/1400F/1400R/1400 Series, please press the clip before removing the card.



3.9 Installing SSD/HDD

The 2.5" hard drive works with both 9.5mm and 7mm drives.

3.9.1 External SSD/HDD for RCX-1400FR/1400R Series

Step 1 Open SSD/HDD Door



Step 2 Insert 2.5" SSD/HDD into the tray.



Step 3 Push back and close the SSD/HDD tray.



Step 4 Lock the SSD/HDD tray with the key.

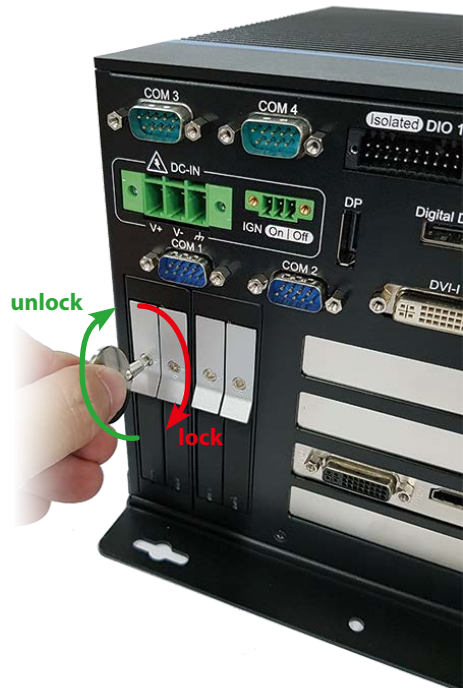

3.9.2 Internal SSD/HDD for RCX-1400F/1400

Step 1 Remove 6#-32 x 5L screws.



Step 2 Open the HDD door and Insert 2.5" SSD/HDD into the tray.



Step 3 Fasten four F Head M3x4L screws (1 set).

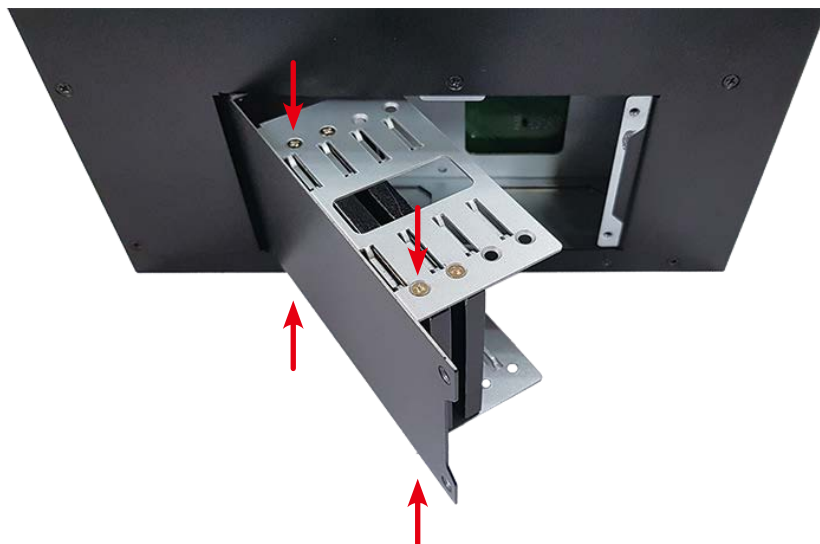

3.9.3 Internal SSD/HDD for RCX-1200

Step 1 Open bottom case



Step 2 Remove two 6#-32 x 5L screws and two M3 x 4L screws.



Step 3 Remove HDD tray.

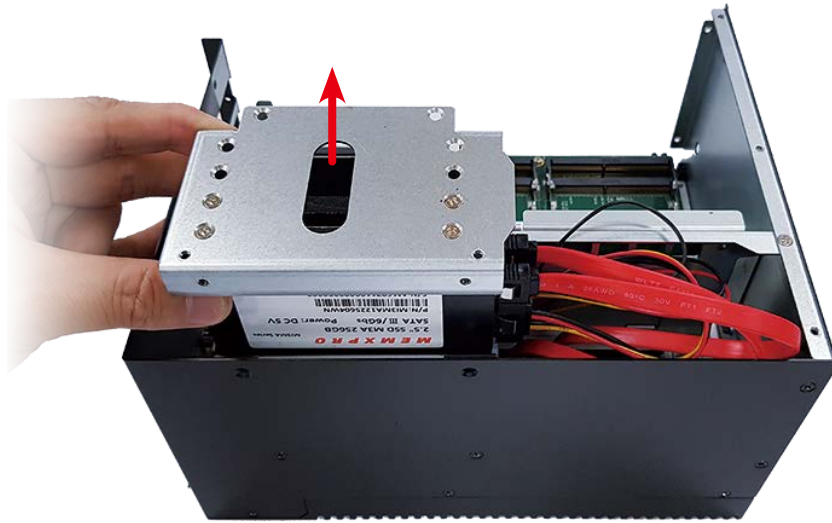

Step 4 Remove cable (yellow mark) and screws (red mark).



3.10 Mounting Your RCX-1000

Step 1 Install wall mount to RCX-1000 bottom.



Step 2 Install four F head #6-32x6L screws.



3.11 Cleaning the Air filter of RCX-1400FR/1400F

Step 1 Remove two F-Head 6#-32 screws (circled in red) on the top cover.



Step 2 Take out the removable filter. (Cleaning the filter with a toothbrush is recommended.)



3.12 Installing the hold down bar for RCX-1400F/1400 Series

Step 1 Fasten screws on two sides of the main frame.
(The default position is L2 and R2. It can be adjusted to L1 and R1 or L3 and R3 depending on the length of the card being fixed.)

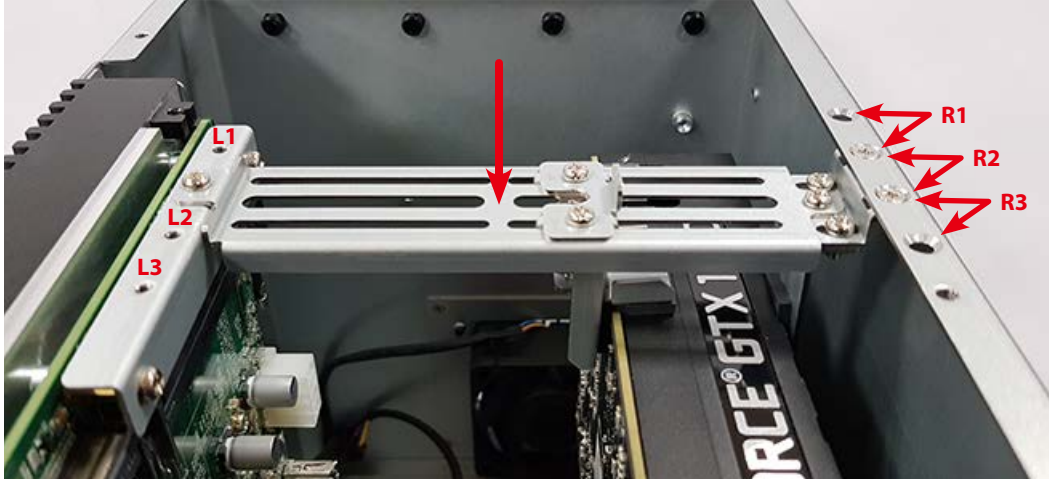

Step 2 Adjust the plate left or right to fix the card and then fasten two screws on the marked yellow area.

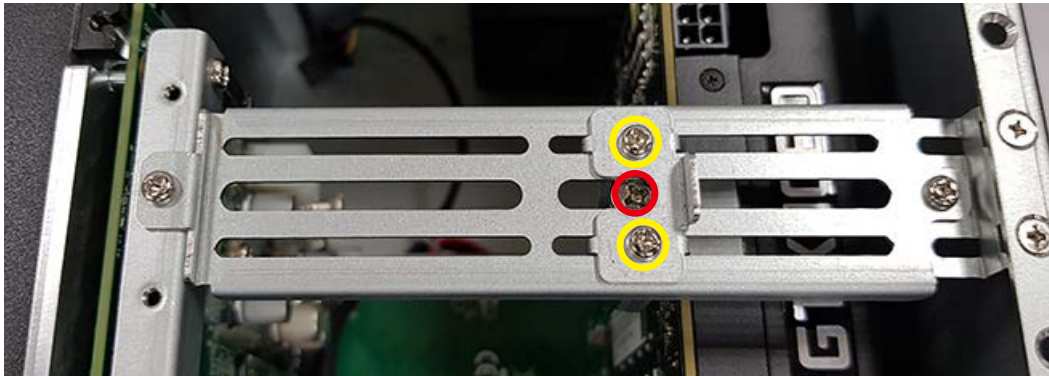

Step 3 Turn the screw (circle in red) left or right with Phillips screwdriver to adjust the pad up and down.

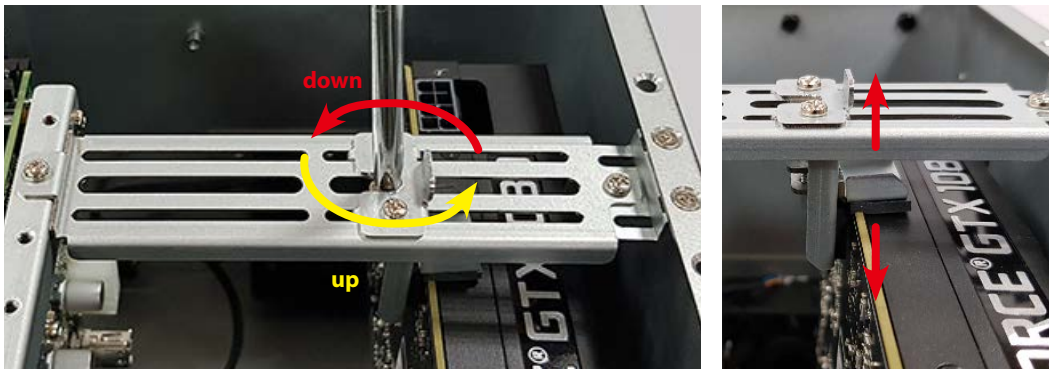

4

BIOS SETUP

4.1 Entering BIOS Setup

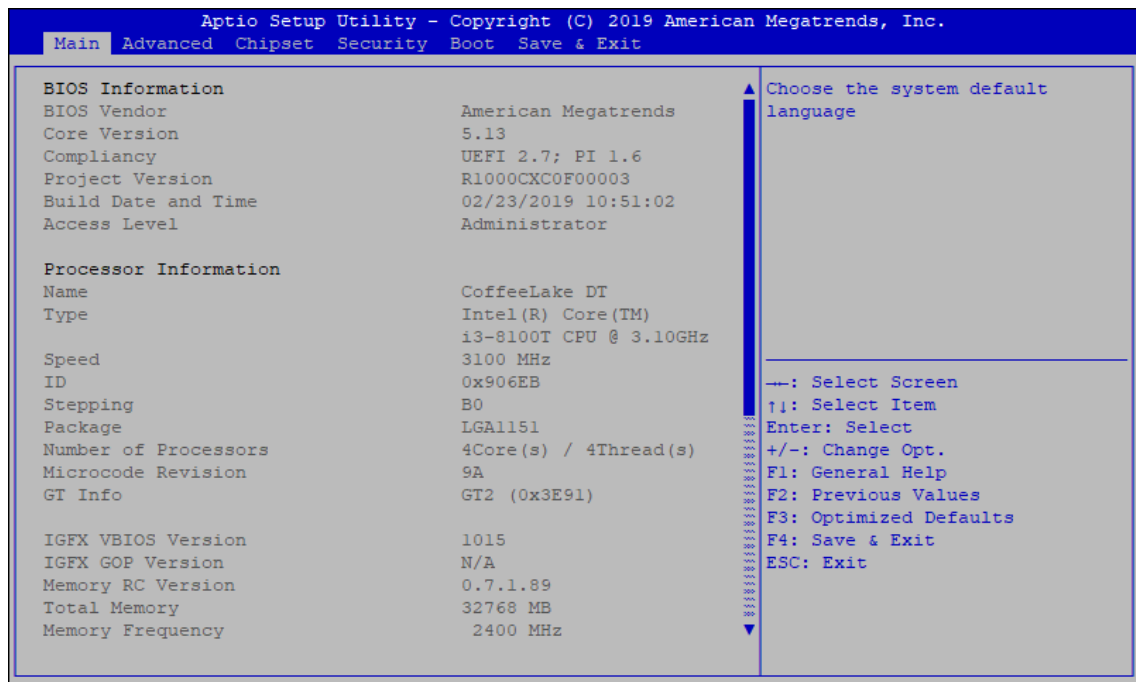

Figure 4-1 : Entering Setup Screen

BIOS provides an interface for users to check and change system configuration. The BIOS setup program is accessed by pressing the key when POST display output is shown.

4.2 Main

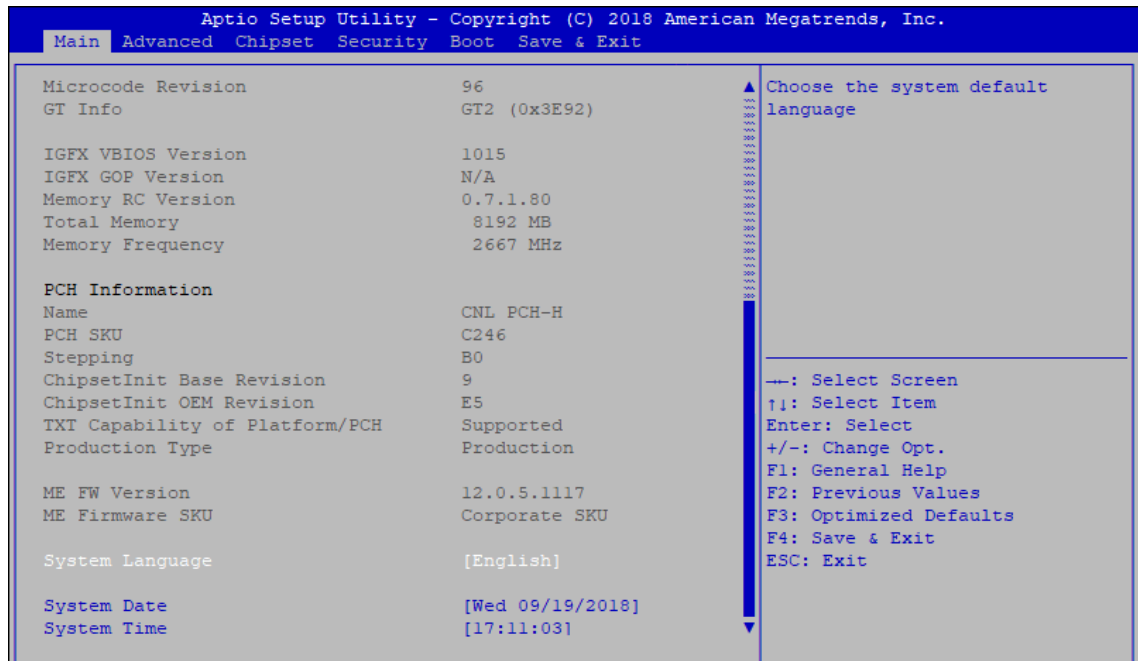

Figure 4-2 : BIOS Main Menu

The main menu displays BIOS version and system information. There are two options on Main menu.

System Date

Set the date. Use <Tab> to switch between date elements.

System Time

Set the time. Use <Tab> to switch between time elements.

4.3 Advanced

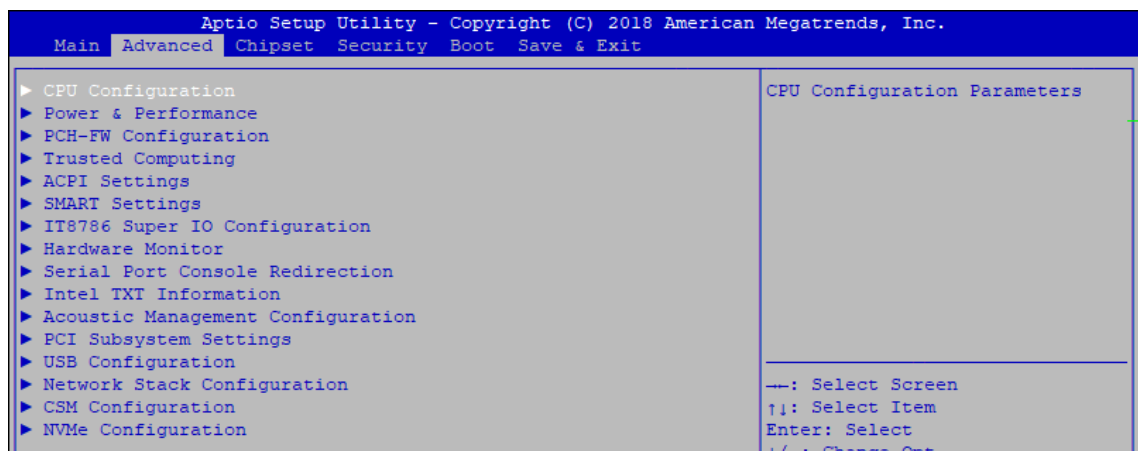

Figure 4-3 : BIOS Advanced Menu

Select advanced tab to enter advanced BIOS setup options, such as CPU configuration, SATA configuration, and USB configuration.

4.3.1 CPU Configuration

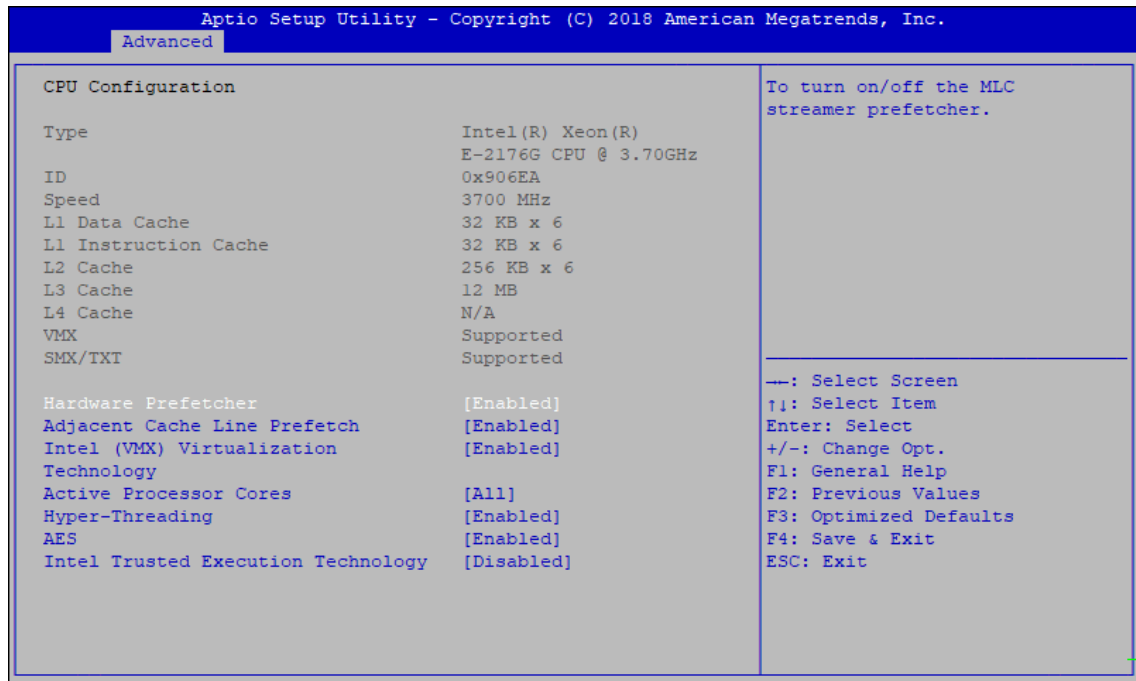

Figure 4-3-1 : CPU Configuration

Hardware Prefetcher

To turn on/off the MLC streamer prefetcher.

Adjacent Cache Line Prefetch

To turn on/off prefetching of adjacent cache lines.

Intel (VMX) Virtualization Technology

When enabled, a VMM can utilize the additional hardware capabilities provided by Vanderpool Technology.

Active Processor Cores

Number of cores to enable in each processor package.

Hyper-threading

Enabled for Windows XP and Linux (OS optimized for Hyper-Threading Technology) and disabled for other OS (OS not optimized for Hyper-Threading Technology). When disabled only one thread per core is enabled.

AES

Enable/disable CPU Advanced Encryption Standard instructions.

Intel Trusted Execution Technology

Enables utilization of additional hardware capabilities provided by Intel® Trusted Execution Technology.

Changes require a full power cycle to take effect.

4.3.2 Power & Performance

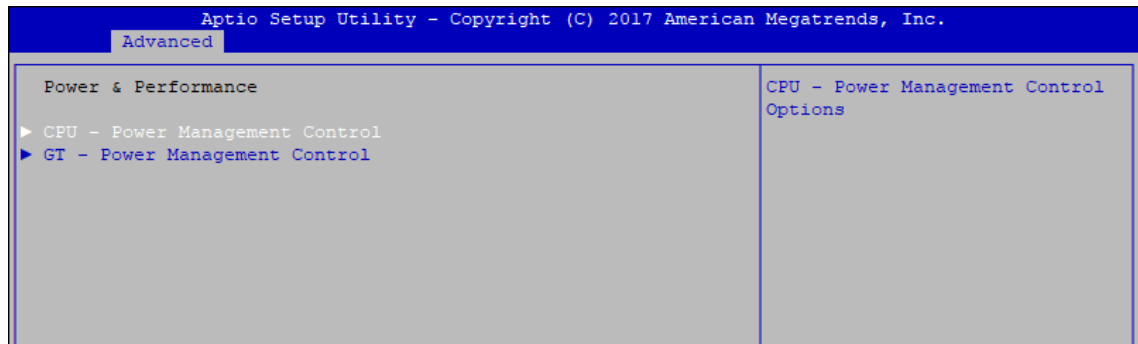

Figure 4-3-2 : Power & Performance

4.3.2.1 CPU – Power Management Control

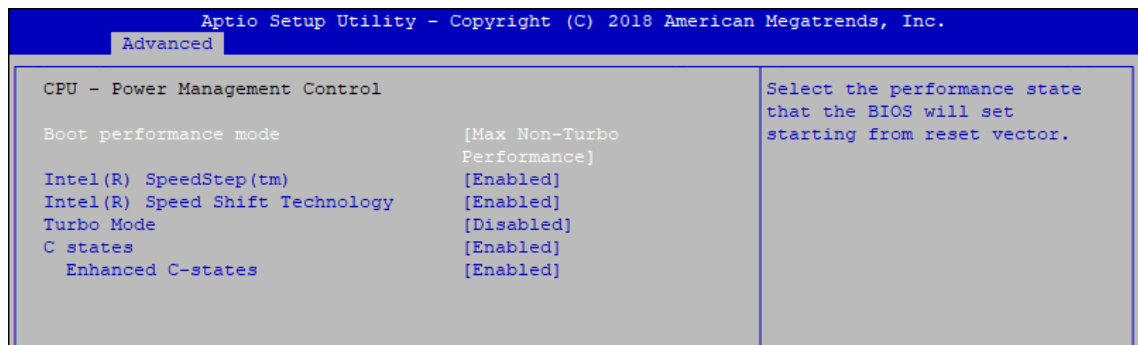

Figure 4-3-2-1 : CPU – Power Management Control

Boot performance mode

Select the performance state that the BIOS will set before OS handoff.

Intel(R) SpeedStep(tm)

Allows more than two frequency ranges to be supported.

Intel(R) Speed shift Technology

Enable/Disable Intel® Speed Shift Technology support. Enabling will expose the CPPCV2 interface to allow for hardware controlled P-states.

Turbo Mode

Turbo Mode.

C states

Enable or disable CPU C states.

Enhanced C-states

Enable/disable C1E. When enabled, CPU will switch to minimum speed when all cores enter C-State.

4.3.2.2 GT – Power Management Control

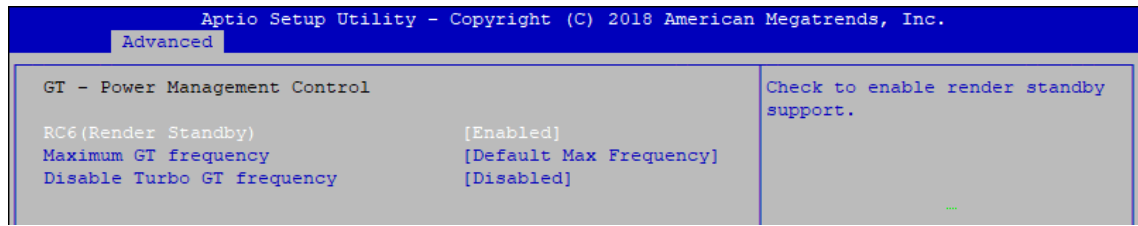

Figure 4-3-2-2 : GT – Power Management Control

RC6 (Render Standby)

Check to enable render standby support.

Maximum GT frequency

Maximum GT frequency limited by the user. Choose between 350MHz (RPN) and 1150MHz (RP0). Value beyond the range will be clopped to min/max supported by SKU

Disable Turbo GT frequency

Check to enable render standby support.

4.3.3 PCH-FW Configuration



Figure 4-3-3 : PCH-FW Settings

ME State

Set ME to Soft temporarily disabled.

AMT BIOS Features

When disabled AMT BIOS Features are no longer supported and user is no longer able to access MEBx Setup.

AMT Configuration

Configure Intel® Active Management Technology Parameters.

ME Unconfig on RTC Clear State

Disabling this option will cause ME not to unconfigure on RTC clear.

4.3.4 Trusted Computing

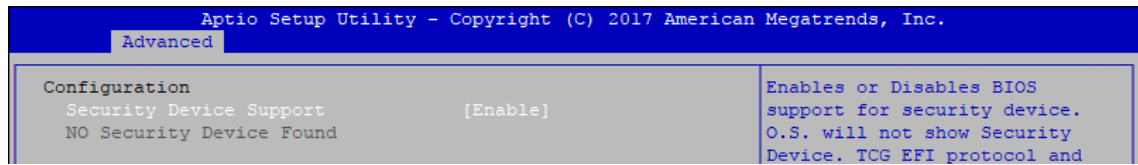

Figure 4-3-4 : Trusted Computing

Control the TPM device status and display related information if TPM chip is present.

4.3.5 ACPI Settings

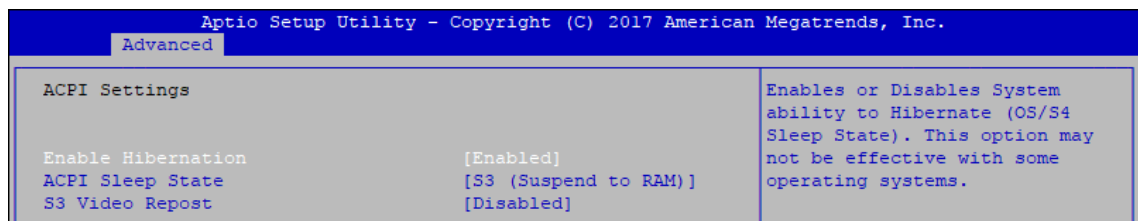

Figure 4-3-5 : ACPI Settings

Enable Hibernation

Enables or disables system's ability to hibernate (OS/S4 sleep state). This option may not be effective with some OS.

ACPI Sleep State

Selects the highest ACPI sleep state the system will enter when the SUSPEND button is pressed.

S3 Video Repost

Enables or disables S3 video repost.

4.3.6 SMART Settings

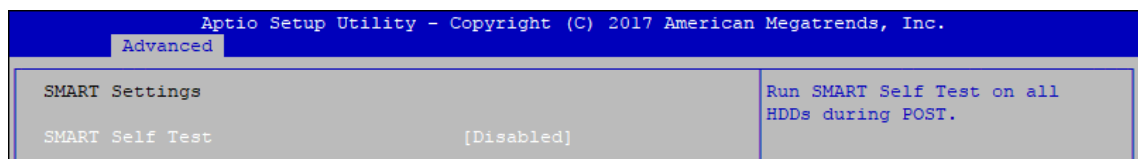

Figure 4-3-6 : SMART Settings

SMART Self Test

Run SMART self test on all HDDs during POST.

4.3.7 IT8786 Super IO Configuration

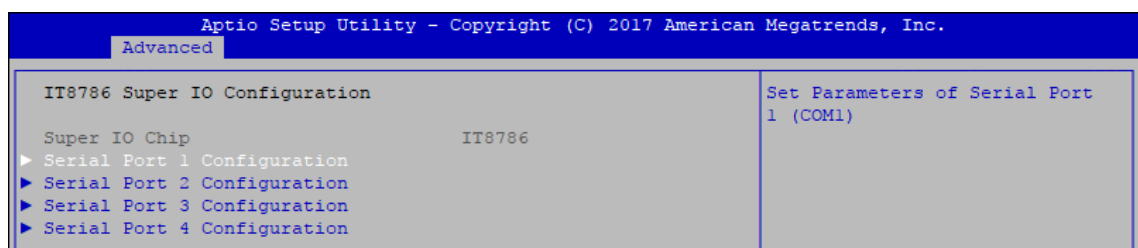

Figure 4-3-7 : IT8786 Super IO Settings

4.3.7.1 Serial Port X Configuration

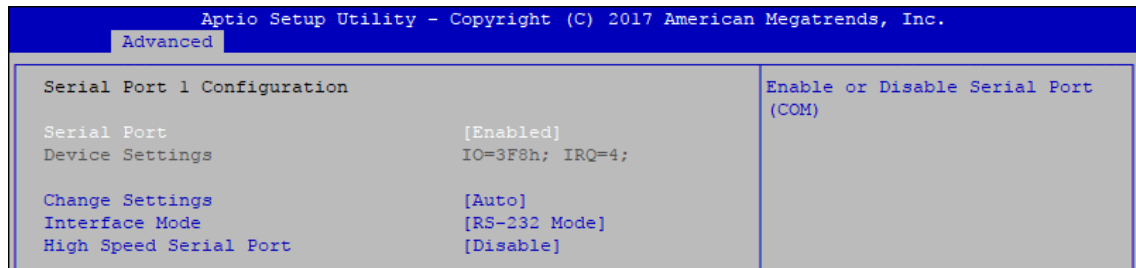

Figure 4-3-7-1 : Serial Port X Configuration

Serial Port 1 to port 4 Configuration

Options for Serial Port 1 to Serial Port 4.

Entering the corresponding Port option then end user can change the settings such as I/O resource and UART mode (High Speed Serial Port is Port 1 only).

4.3.8 Hardware Monitor

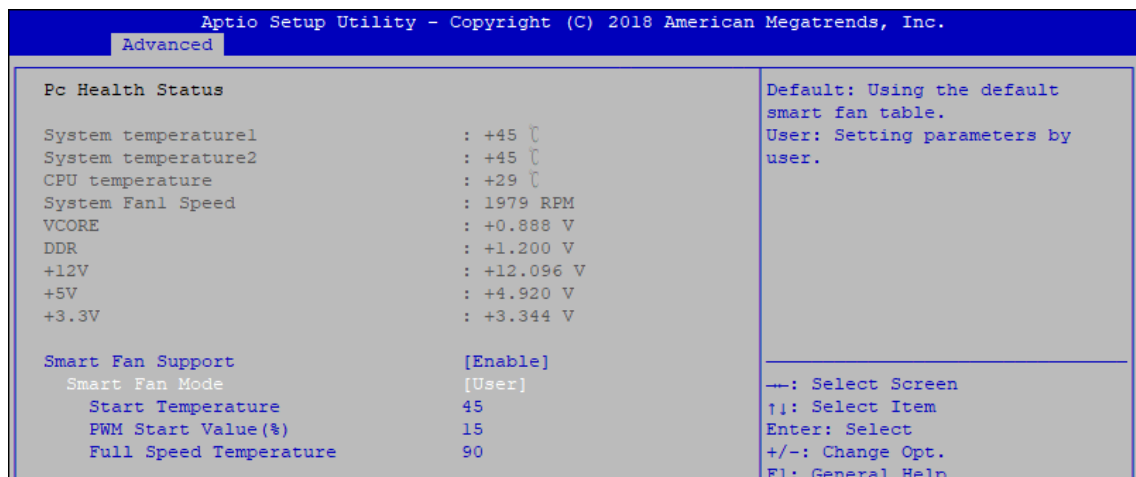

Figure 4-3-8 : Hardware Monitor Settings

The IT8786 SIO features an enhanced hardware monitor providing thermal, fan speed, and system voltages' status monitoring.

Smart Fan Support

Smart Fan Support. Work with Full Speed if "Smart Fan Support" is Disabled.

Smart Fan Mode

Default : Using the default smart fan table.

User : Setting parameters by user.

Start Temperature

Temperature Limit value of Fan Start (Degree C).

(Range : 10~80)

PWM Start Value (%)

Default PWM Value of Fan.

(Range : 15%~100%)

Full Speed Temperature

Temperature Limit value of Fan Full Speed (Degree C).

(Range : 50~90)

4.3.9 Serial Port Console Redirection

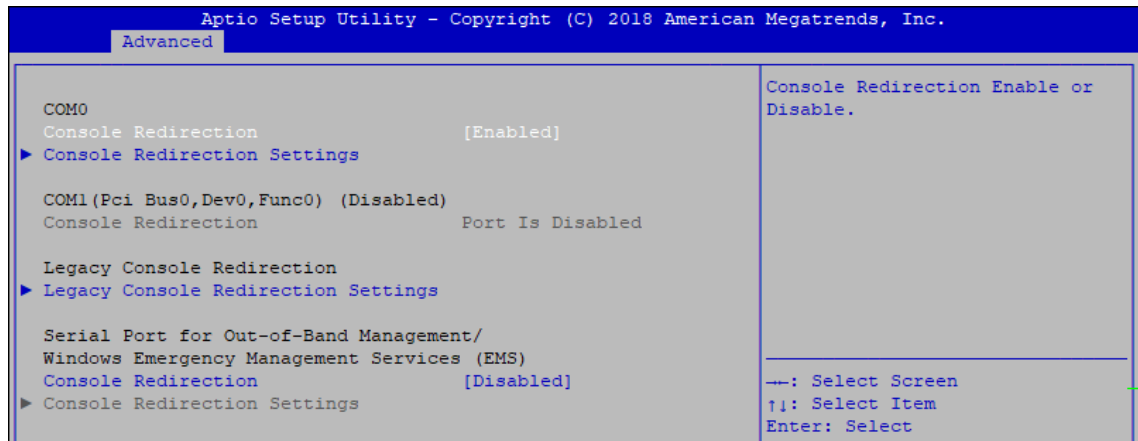

Figure 4-3-9 : Serial Port Console Redirection Settings

Console Redirection

Console redirection enable or disable.

Console Redirection Settings

These settings specify how the host computer and the remote computer (which the user is using) will exchange data. Both computers should have the same or compatible settings.

Legacy Console Redirection

Legacy Console Redirection Settings.

Serial Port for Out-of-Band Management/Windows Emergency Management Services (EMS)

Console redirection enable or disable.

4.3.10 Intel TXT Information

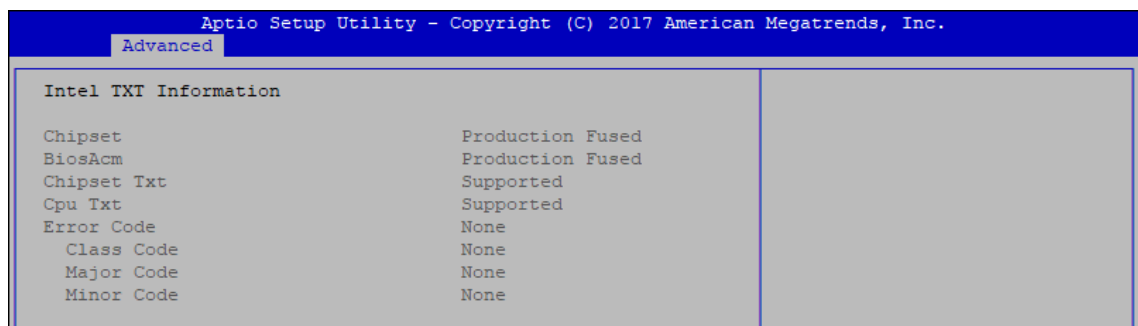

Figure 4-3-10 : Intel TXT Information

Display Intel TXT information.

4.3.11 Acoustic Management Configuration



Figure 4-3-11 : Acoustic Management Settings

Acoustic Management Configuration

Option to enable or disable automatic acoustic management.

4.3.12 PCI Subsystem Setting

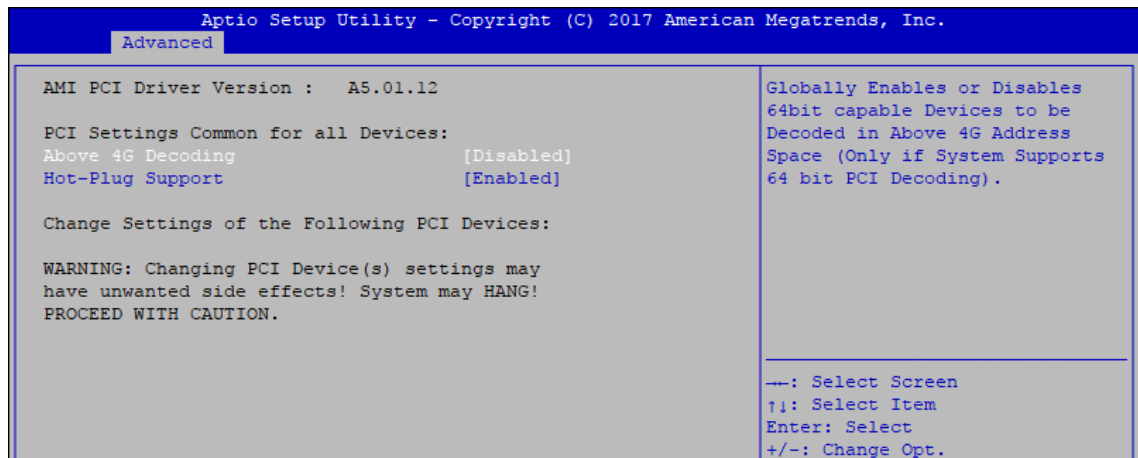

Figure 4-3-12 : PCI Subsystem Settings

Above 4G Decoding

Globally Enables or Disables 64bit capable Devices to be Decoded in Above 4G Address Space (Only if System Supports bot PCI Decoding)

Hot-Plug Support

Globally Enables or Disables Hot-Plug support for the entire System. If system has Hot-Plug Capable Slots and this option is set to Enabled, it provides a Setup screen for selecting PCI resource padding for Hot-Plug.

4.3.13 Network Stack Configuration

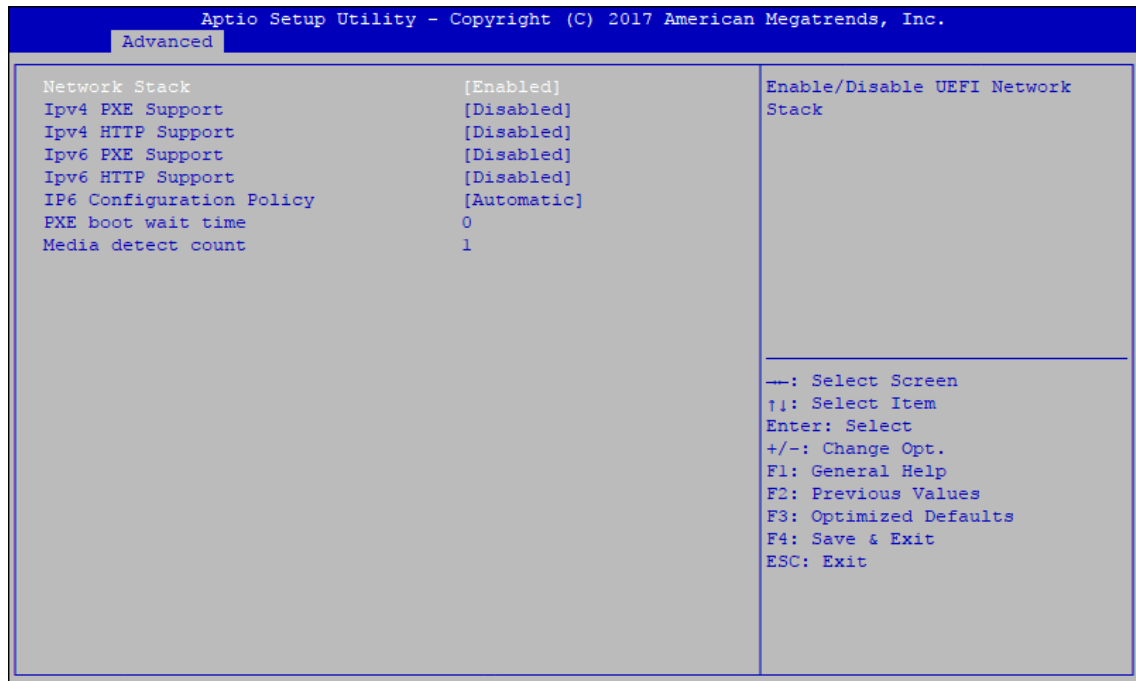

Figure 4-3-13 : Network Stack Settings

Network Stack

Enable/Disable UEFI Network Stack.

Ipv4 PXE Support

Enable/Disable IPv4 PXE boot support.

Ipv4 HTTP Support

Enable/Disable IPv4 HTTP boot support.

Ipv6 PXE Support

Enable/Disable IPv6 PXE boot support.

Ipv6 HTTP Support

Enable/Disable IPv6 HTTP boot support.

IP6 Configuration Policy

Set IP6 Configuration Policy.

PXE boot wait time

Wait time to press ESC key to abort the PXE boot.

Media detect count

Number of times presence of media will be checked.

4.3.14 CSM Configuration

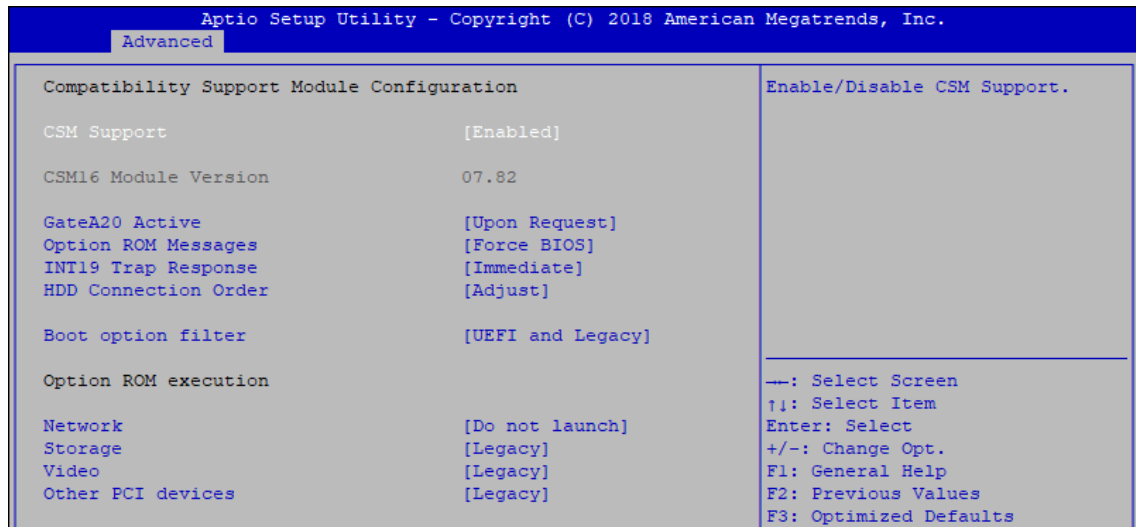

Figure 4-3-14 : CSM Settings

CSM Support

Enable/disable CSM support

GateA20 Active

UPON REQUEST - GA20 can be disabled using BIOS services.

ALWAYS - do not allow GA20 to be disabled; this option is useful when any RT code is executed above 1MB.

Option ROM Messages

Set display mode for Option ROM.

INT19 Trap Response

BIOS reaction on INT19 trapping by Option ROM :

IMMEDIATE - execute the trap right away;

POSTPONED - execute the trap during legacy boot.

HDD Connection Order

Some OS require HDD handles to be adjusted, i.e. OS is installed on drive 80h.

Boot option filter

This option controls Legacy/UEFI ROM's priority.

Network

Controls the execution of UEFI and Legacy PXE OpROM.

Storage

Controls the execution of UEFI and Legacy Storage OpROM.

Video

Allows more than two frequency ranges to be supported.

Other PCI devices

Determines OpROM execution policy for devices other than network, storage, or video.

4.3.15 NVMe Configuration

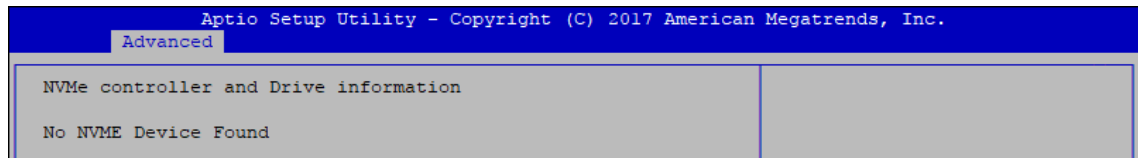

Figure 4-3-15 : NVMe Settings

Display NVMe controller and Drive information.

4.3.16 USB Configuration

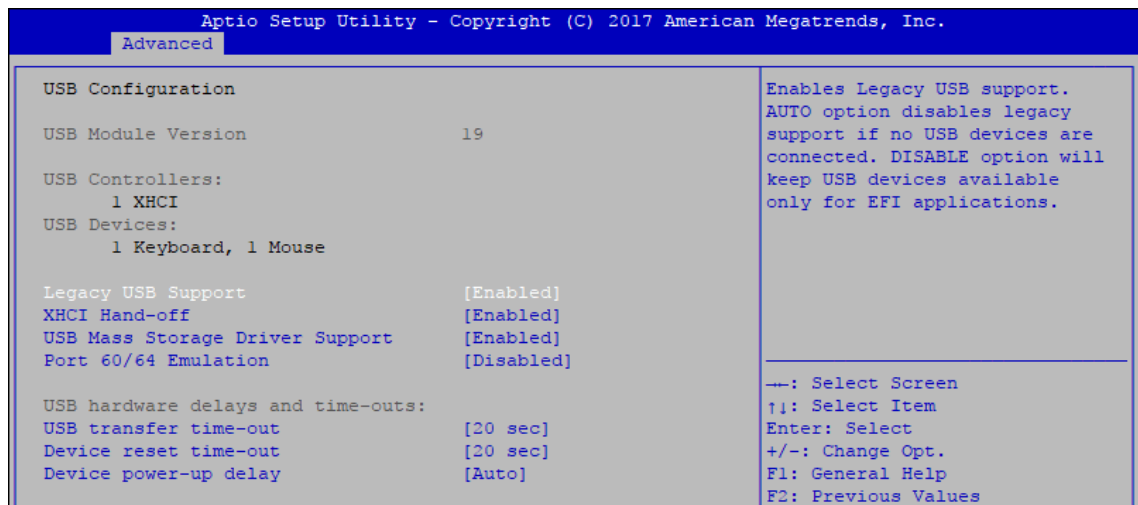

Figure 4-3-16 : USB Settings

Legacy USB Support

Enables Legacy USB support.

AUTO option disables Legacy support if no USB devices are connected.

DISABLE option will keep USB devices available only for EFI applications.

XHCI Hand-off

This is a workaround for OS-es without XHCI hand-off support. The XHCI ownership change should be claimed by XHCI driver.

USB Mass Storage Driver Support

Enable/disable USB mass storage driver support.

Port 60/64 Emulation

Enables I/O port 60h/64h emulation support. This should be enabled for the complete USB keyboard legacy support for non-USB aware OSes.

USB transfer time-out

The time-out value for control, bulk, and interrupt transfers.

Device reset time-out

USB mass storage device start unit command time-out.

Device power-up delay

Maximum time the device will take before it properly reports itself to the Host Controller. 'Auto' uses default value, for a root port it is 100 ms, for a hub port the delay is taken from the hub descriptor.

4.4 Chipset

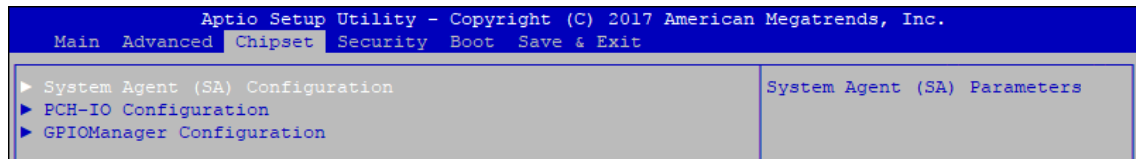

Figure 4-4 : BIOS Chipset Menu

System Agent (SA) Configuration

System Agent (SA) parameters.

PCH-IO Configuration

PCH parameters.

GPIOManager Configuration

GPIOManager Configuration.

4.4.1 System Agent (SA) Configuration

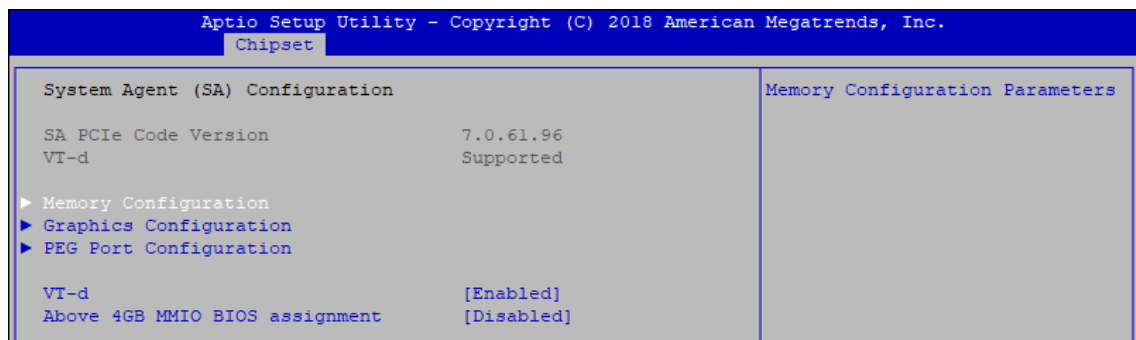

Figure 4-4-1 : System Agent Settings

VT-d

VT-d capability.

Above 4GB MMIO BIOS assignment

Enable/disable above 4GB MemoryMappedIO BIOS assignment. This is disabled automatically when aperture size is set to 2048MB.

4.4.1.1 Memory Configuration

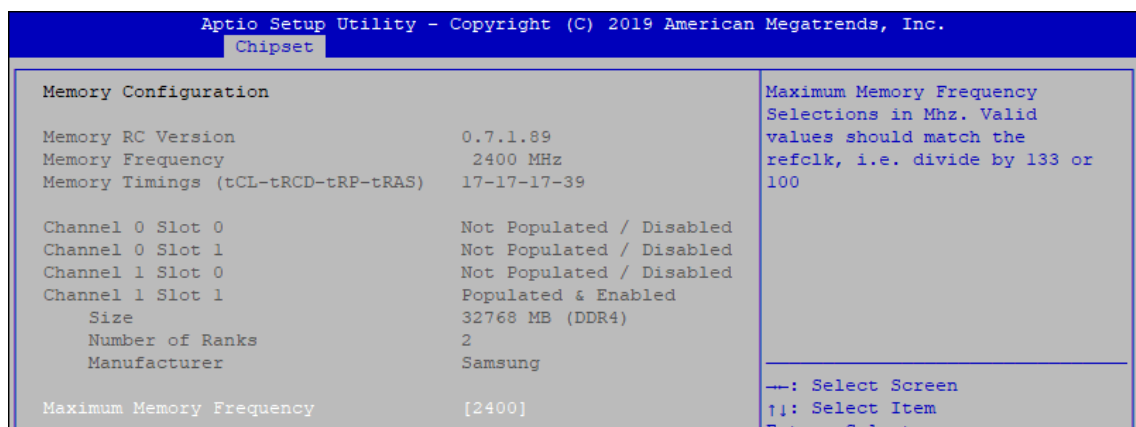

Figure 4-4-1-1 : Memory Information

Displays memory information.

4.4.1.2 Graphics Configuration

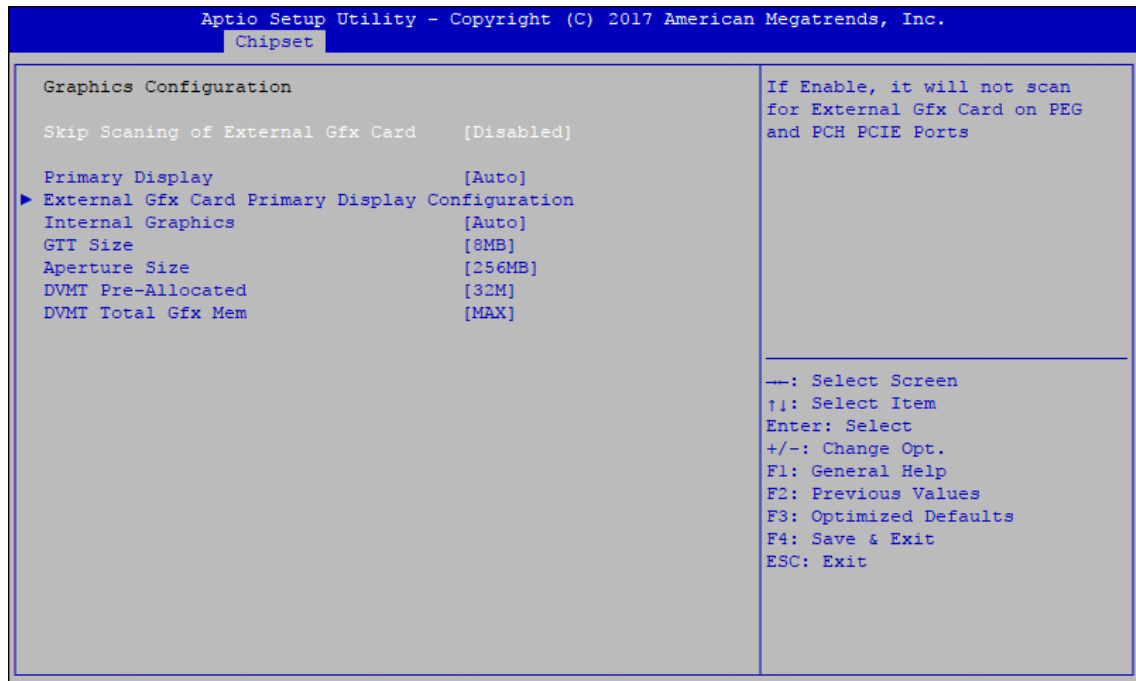

Figure 4-4-1-2 : Graphics Settings

Skip Scanning of External Gfx Card

If enabled, it will not scan for External Gfx Card on PEG and PCH PCIE Ports.

Primary Display

Select which of IGFX/PEG/PCI Graphics device should be Primary Display Or select SG for Switchable Gfx.

Internal graphics

Keep IGFX enabled based on the setup options.

GTT Size

Select the GTT Size.

Aperture Size

Select the Aperture Size.

Note : Above 4GB MMIO BIOS assignment is automatically enabled when selecting 2048MB aperture. To use this feature, please disable CSM Support.

DVMT Pre-Allocated

Select DVMT 5.0 Pre-Allocated (Fixed) Graphics Memory size used by the Internal Graphics Device.

DVMT Total Gfx Mem

Select DVMT5.0 Total Graphic Memory size used by the Internal Graphics Device.

4.4.1.3 PEG Port Configuration

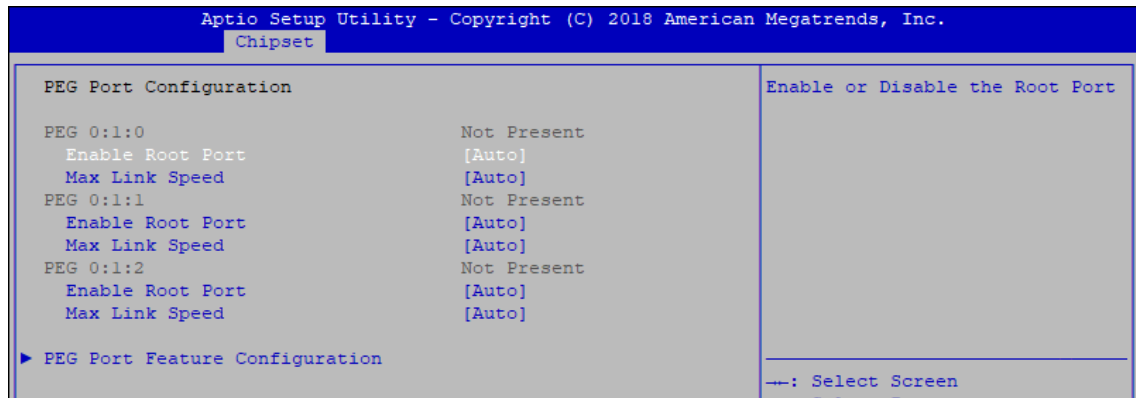

Figure 4-4-1-3 : PEG Port Configuration

PEG port options for PCIe device.

4.4.2 PCH-IO Configuration

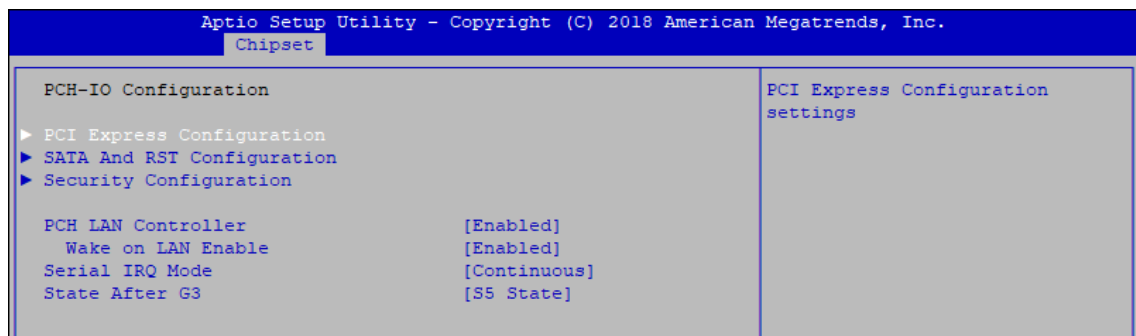

Figure 4-4-2 : PCH-IO Settings

PCH LAN Controller

Enable or disable onboard NIC.

Wake on LAN

Enable or disable integrated LAN to wake the system. (The wake On LAN cannot be disabled if ME is on at Sx state.)

Serial IRQ Mode

Configure serial IRQ mode.

State After G3

Specify what state to go to when power is re-applied after a power failure (G3 state).

S0 State : Always turn-on the system when power source plugged-in.

S5 State : Always turn-off the system when power source plugged-in.

4.4.2.1 PCI Express Configuration of PCH-IO



Figure 4-4-2-1 : PCH-IO Settings

DMI Link ASPM Control

Enable/Disable the control of Active State Power Management on SA side of the DMI Link.

Native PCIE Enable

PCIE Express Native Support Enable/Disable.

PCI Express device settings

Bios options for PCI Express device setting.

4.4.2.2 SATA and RST Configuration

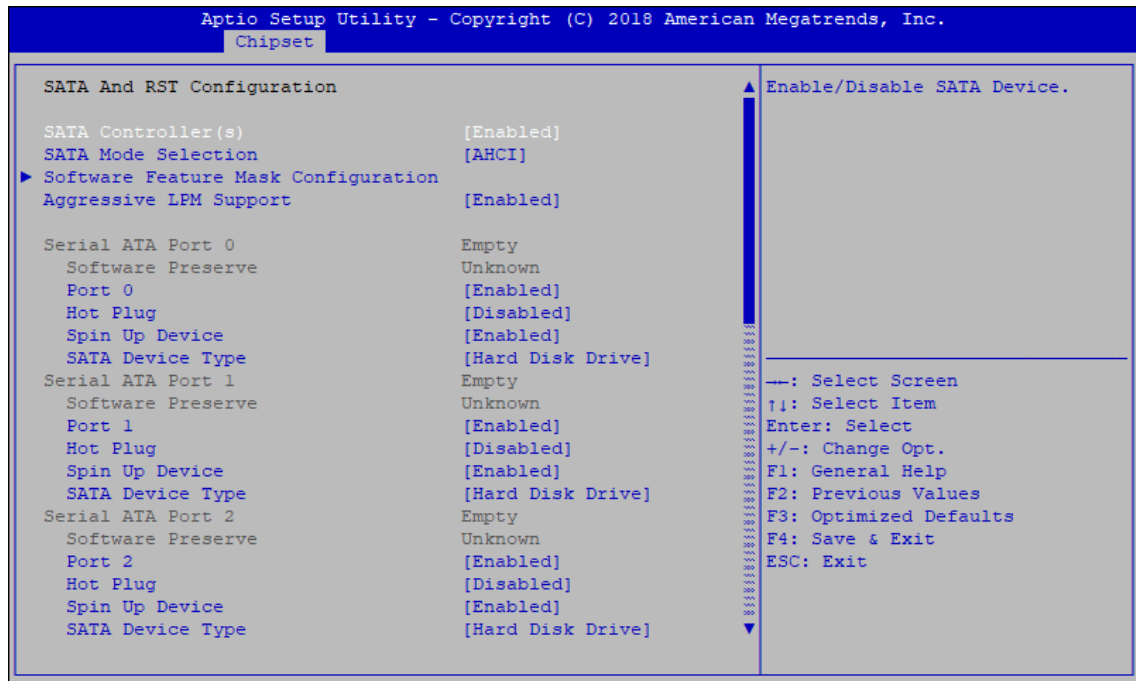

Figure 4-4-2-2 : SATA and RST Settings

SATA Controller(s)

Enable or disable SATA Device.

SATA Mode Selection

Determines how SATA controller(s) operate.

Software Feature Mask Configuration

RAID OROM/RST driver will refer to the SWFM configuration to enable or disable the storage features.

Aggressive LPM Support

Enable PCH to aggressively enter link power state.

Options for each SATA port :

Port n

Enable or disable SATA Port.

Hot Plug

Designated this port as Hot Pluggable.

Spin Up Device

On an edge detect from 0 to 1, the PCH starts a COMRESET initialization sequence to the device.

SATA Device Type

Identifies that the SATA port is connected to solid state drive or hard disk drive.

4.4.2.3 Security Configuration

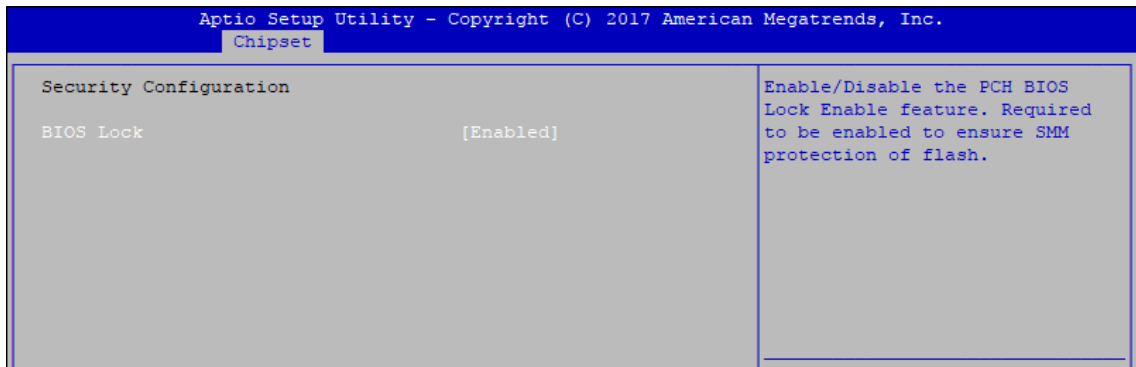

Figure 4-4-2-3 : Security Settings

BIOS Lock

Enable/disable the PCH BIOS Lock Enable (BLE bit) feature.

4.4.3 GPIOManager Configuration

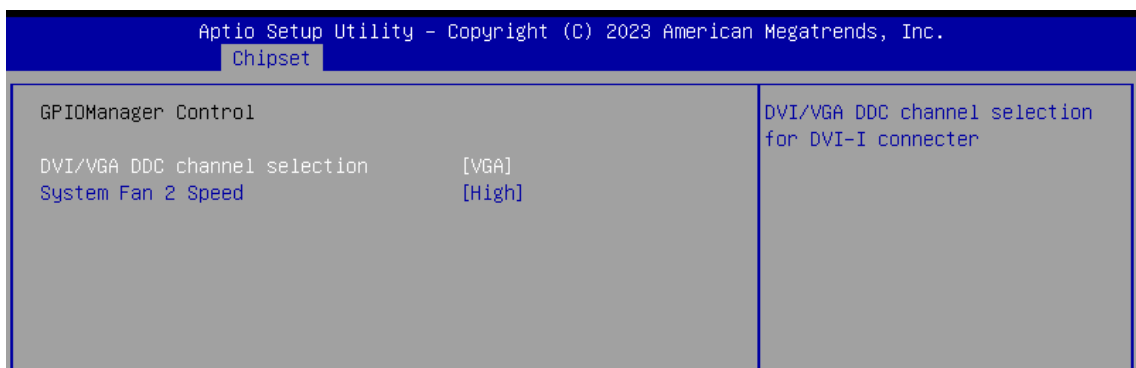

Figure 4-4-3 : GPIOManager Configuration

DVI/VGA DDC channel selection

DVI/VGA channel selection for DVI-I connector.

System Fan 2 Speed

System Fan 2 speed control (High/Mid/Low).

4.5 Security

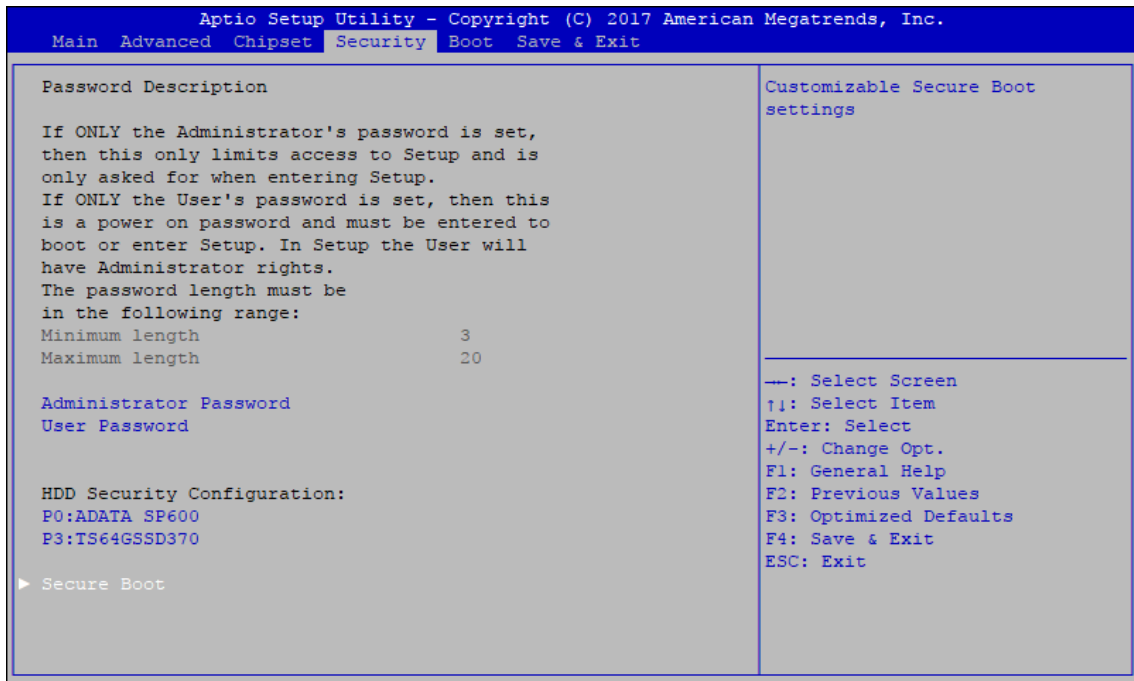

Figure 4-5 : BIOS Security Menu

Administrator Password

Set administrator password.

User Password

Set user password.

Secure Boot

Customizable Secure Boot Settings.

4.5.1 HDD Security Configuration

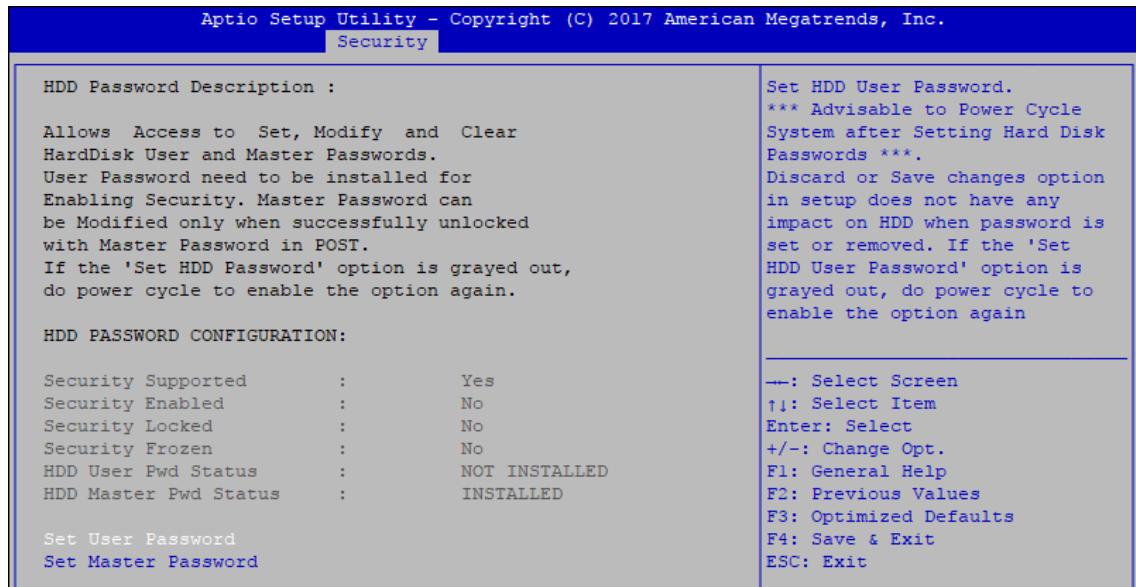

Figure 4-5-1 : HDD Security Settings

Set User Password

Set HDD user password.

*** Advisable to power cycle system after setting hard disk passwords ***

Discard or save changes option in setup does not have any impact on HDD when password is set or removed. If the 'Set HDD User Password' option is gray, do power cycle to enable the option again.

4.5.2 Security Boot

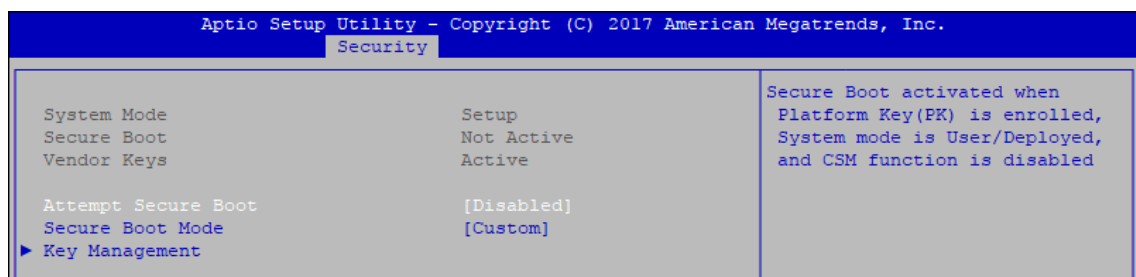

Figure 4-5-2 : Security Boot Settings

Attempt Secure Boot

Secure Boot activated when Platform Key (PK) is enrolled, System mode is User/Deployed, and CSM function is disabled.

Secure Boot Mode

Secure Boot mode selector Standard/Custom.

In custom mode Secure Boot Variables can be configured without authentication.

Key Management

Enables expert users to modify Secure boot policy variables without full authentication.

4.6 Boot

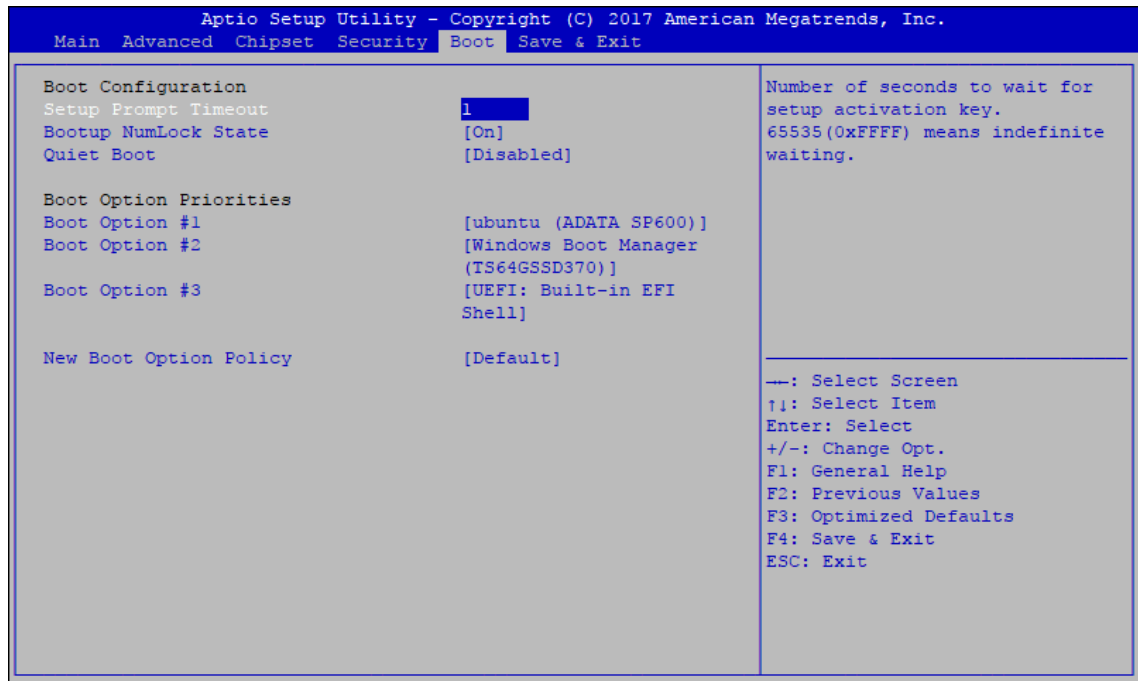

Figure 4-6 : BIOS Boot Menu

Setup Prompt Timeout

Number of seconds to wait for setup activation key. 65535 (0xFFFF) means indefinite waiting.

Bootup NumLock State

Select the keyboard NumLock state.

Quiet Boot

Enables or disables Quiet Boot option.

Boot Option

Sets the system boot order.

New Boot Option Policy

Controls the placement of newly detected UEFI boot options.

Hard Drive BBS Priorities

Set the order of the Legacy devices in this group.

4.7 Save & Exit

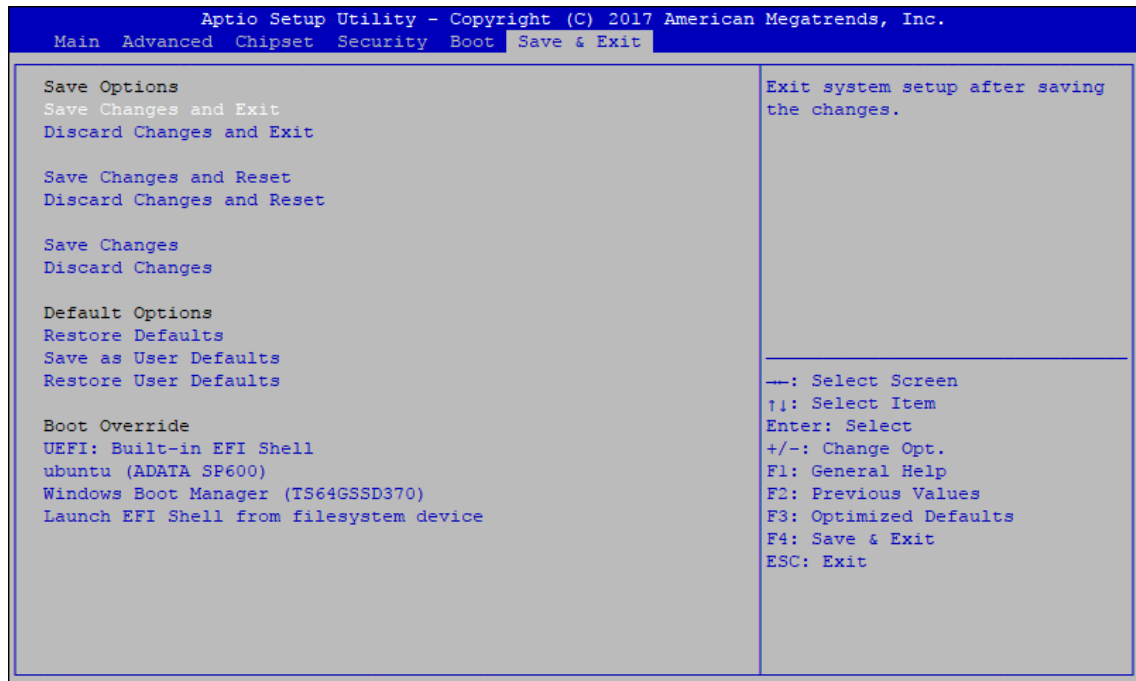

Figure 4-7 : BIOS Save and Exit Menu

Save Changes and Exit

Exit system setup after saving the changes.

Discard Changes and Exit

Exit system setup without saving any changes.

Save Changes and Reset

Reset the system after saving the changes.

Discard Changes and Reset

Reset system setup without saving any changes.

Save Changes

Save Changes done so far to any of the setup options.

Discard Changes

Discard Changes done so far to any of the setup options.

Default Options

Restore Defaults

Restore/Load Default values for all the setup options.

Save as User Defaults

Save the changes done so far as User Defaults.

Restore User Defaults

Restore the User Defaults to all the setup options.

A

APPENDIX A : Isolated DIO Guide

A.1 Function Description

The RCX-1000 offers two 16-bit Isolated DIO 20-pin terminal block connectors and a watchdog timer.

Isolated DIO pins are fixed by Hardware design that cannot change in/out direction in runtime process.

DIO definition is shown below :

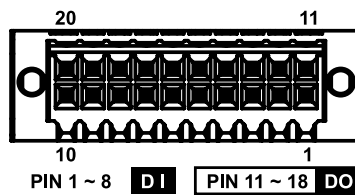

Pin No.	Isolated DIO	Non-Isolated DIO Definition	Pin No.	Isolated DIO Definition	Non-Isolated DIO Definition
1	DI 0	DIO 0	11	DO 0	DIO 8
2	DI 1	DIO 1	12	DO 1	DIO 9
3	DI 2	DIO 2	13	DO 2	DIO 10
4	DI 3	DIO 3	14	DO 3	DIO 11
5	DI 4	DIO 4	15	DO 4	DIO 12
6	DI 5	DIO 5	16	DO 5	DIO 13
7	DI 6	DIO 6	17	DO 6	DIO 14
8	DI 7	DIO 7	18	DO 7	DIO 15
9	DI COM	NC	19	DIO_GND	DIO_GND
10	DIO_GND	DIO_GND	20	External VDC	NC

A.2 Isolated DIO Signal Circuit

DI reference circuit :

Sink Mode
(NPN)

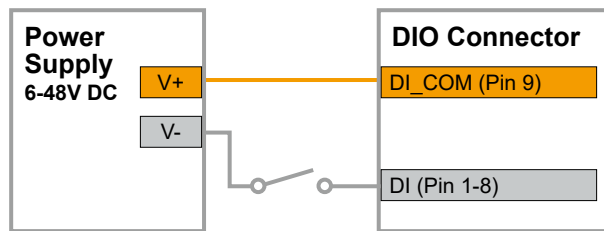

Source Mode
(PNP)

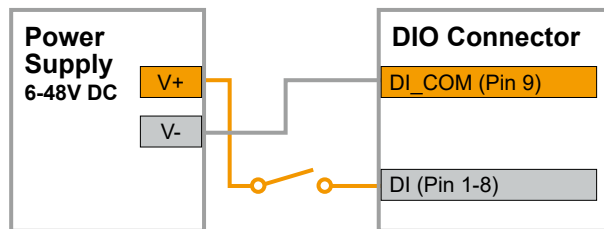

DO reference circuit :

Sink Mode
(NPN, Default)

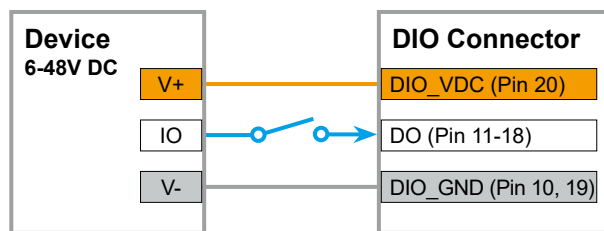

Source Mode
(PNP)

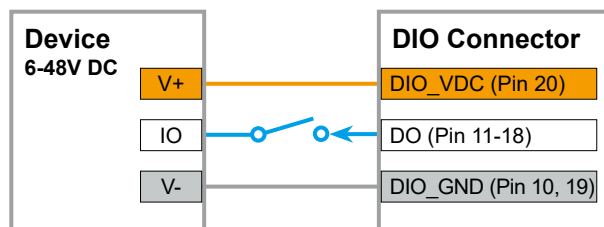

A.3 Software Package Contain

Distribution folder include x32 and x64 versions, use batch file for installation.

There are included as followed :

Win7_32.bat :

Installation for 32-bit driver

Win7_64.bat :

Windows update package which driver required (need to restart), and Installation for 64-bit driver

Win8_32.bat, Win8_64.bat :

Installation for driver, and guideline to Framework 3.5 distribution for sample

Win10_32.bat, and Win10_64.bat :

Installation for driver, and installation to Framework 3.5 distribution for sample

Uninstall_32.bat, and Uninstall_64.bat :

Uninstallation for driver

Run batch file as Administrator.

Support Windows 7 above.

Make sure it is Windows version before installation.

Runtime folder includes head file for software developer or System Integration.

Sample folder includes sample program, driver library, and API library. Source

folder includes sample program source code that compile on Visual Studio 2008.

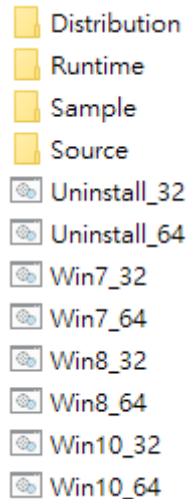

A.4 Sample

Sample folder includes x32 and x64 versions, as shown right :

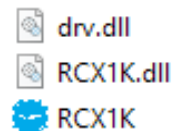

Sample RCX1K.exe, as shown below :

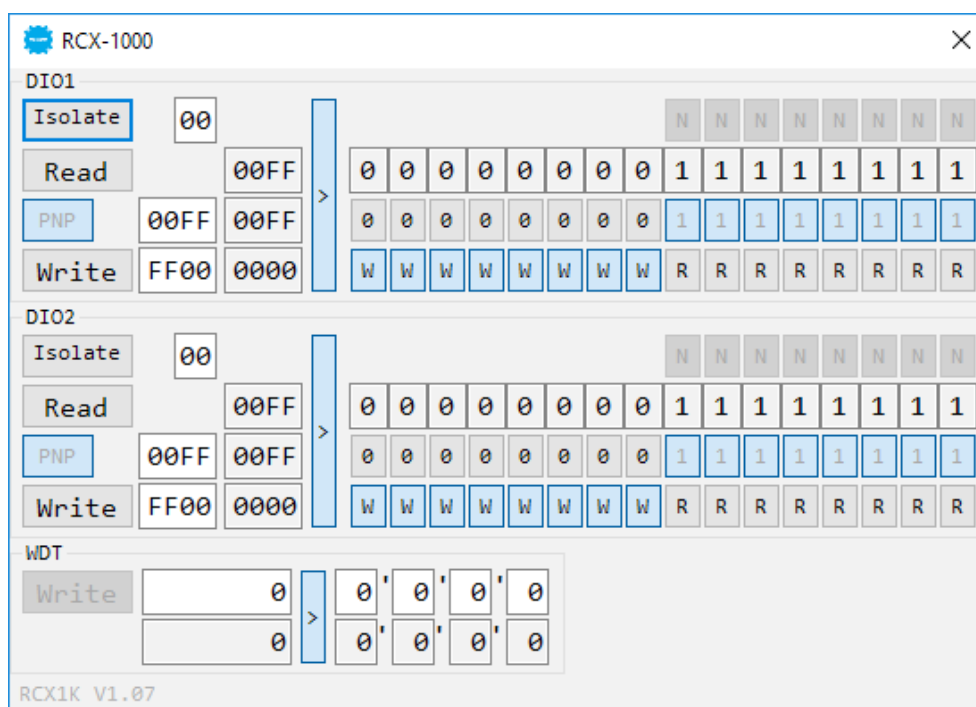

DIO1/DIO2 group :

Isolate check button :

DIO type of DIO configuration, isolated/non-isolated.

Read button :

Set DIO configuration to get DI/DIO input state.

DO type check button :

User setting, DO type of DIO configuration to setup 8 pins - Source/Sink.

Use for Write (DO) button activation.

Write button :

Set DIO configuration to set DO/DIO output state.

DI preference text :

User setting, DI type of DIO configuration by hexadecimal bitmask - Source/Sink.

Use for Read (DI) button activation.

DO/DIO output text :

User setting, DO/DIO output state by hexadecimal bitmask - on/off.

Use for Write button activation.

DO/DIO writable text :

User setting, DO/DIO writable of DIO configuration by hexadecimal bitmask - yes/no.

Use for Read (DIO)/Write button activation.

DI/DIO input text (read only) :

DI/DIO input state by hexadecimal bitmask - on/off.

Use for Read button activation.

DO/DIO text (read only) :

DO/DIO output state with input state (DIO) and configuration.

Use for Write button activation.

DO/DIO output text (read only) :

DO/DIO output state with configuration.

Use for Write button activation.

DI type pin check button (pin 8 ~ pin 1) :

User setting, DI pin type of DIO configuration - Source/Sink.

DI/DIO input pin texts (read only, pin 8 ~ pin 1/pin 18 ~ pin 11, pin 8 ~ pin 1) :

DI/DIO input pin state

Use for Read button activation.

DO/DIO output pin check button (pin 18 ~ pin 11/pin 18 ~ pin 11, pin 8 ~ pin 1) :

User setting, DO/DIO output pin state

Use for Write button activation.

DO/DIO pin writable check button (pin 18 ~ pin 11/pin 18 ~ pin 11, pin 8 ~ pin 1) :

User setting, DO/DIO pin writable of DIO configuration.

Use for Read (DIO)/Write button activation.

WDT group :

Write button :

Set WDT when WDT setup text is valid.

Stop button :

Cancel WDT and counting.

Use after Write button action.

WDT setup text :

User setting, WDT value, unit : second.

Use for Write button activation.

WDT counting text (read only) :

WDT counting by program timer after set WDT.

Shown after Write button action.

WDT setup day format texts (user setting) :

User setting, WDT value, format : day'hour'minute'second.

WDT counting day format text (read only) :

WDT counting, format : day'hour'minute'second.

B

APPENDIX B : Software Functions

B.1 Driver API Guide

In Runtime folder, on RCX1K.h :

 _DLL_IMPORT_ definition is used on LoadLibrary API for RCX1K.dll.
 RCX1K_EXPORTS definition is used on RCX1K.dll building.

BOOL Initial (BYTE Isolate_Type, BYTE DIO_NPN)

Initial machine for DIO, watchdog timer

 Isolate_Type : DIO type

 1 : Isolated DIO;

 0 : Non-Isolated DIO

 DIO_NPN : DI/DO type

 1 : PNP (Source) mode for European rule;

 0 : NPN (Sink) mode for Japanese rule

Return :

 TRUE (1) : Success;

 FALSE (0) : Fail (Driver not exists, or initial error (version is too old, or machine not match))

BOOL GetDIO1Config (BYTE *Isolate_Type, BYTE *DI_NPN, BYTE *DO_NPN, WORD *Mask)

BOOL GetDIO2Config (BYTE *Isolate_Type, BYTE *DI_NPN, BYTE *DO_NPN, WORD *Mask)

Get DIO configuration (by variable)

 Isolate_Type : DIO type

 1 : Isolated DIO;

 0 : Non-Isolated DIO

 DI_NPN ([7:0]) : DI type, pin setting by hexadecimal bitmask

 1 : PNP (Source) mode for European rule;

 0 : NPN (Sink) mode for Japanese rule

 DO_NPN : DO type

 1 : PNP (Source) mode for European rule;

 0 : NPN (Sink) mode for Japanese rule

 Mask ([15:0]) : In/Out, pin setting by hexadecimal bitmask

 1 : Output;

 0 : Input

Return :

 TRUE (1) : Success;

 FALSE (0) : Fail (Initial error, or call by pointer error, or hardware problem)

BOOL SetDIO1Config (BYTE Isolate_Type, BYTE DI_NPN, BYTE DO_NPN, WORD Mask)

BOOL SetDIO2Config (BYTE Isolate_Type, BYTE DI_NPN, BYTE DO_NPN, WORD Mask)

Set DIO configuration

Isolate_Type : DIO type

1 : Isolated DIO;

0 : Non-Isolated DIO

DI_NPN ([7:0]) : DI type, pin setting by hexadecimal bitmask

1 : PNP (Source) mode for European rule;

0 : NPN (Sink) mode for Japanese rule

DO_NPN : DO type

1 : PNP (Source) mode for European rule;

0 : NPN (Sink) mode for Japanese rule

Mask ([15:0]) : In/Out, pin setting by hexadecimal bitmask

1 : Output;

0 : Input

Return :

TRUE (1) : Success;

FALSE (0) : Fail (Initial error, or hardware problem)

BOOL GetDI1 (BYTE *DI)

BOOL GetDI2 (BYTE *DI)

GGet isolated DIO input (DI)

DI ([7:0]) : Input state, pin setting by hexadecimal bitmask

1 : High;

0 : Low

Return :

TRUE (1) : Success;

FALSE (0) : Fail (Initial error, or call by pointer error, or hardware problem)

BOOL GetDO1 (BYTE *DO)

BOOL GetDO2 (BYTE *DO)

Get isolated DIO output (DO)

DO ([7:0]) : Output state, pin setting by hexadecimal bitmask

1 : High;

0 : Low

Return :

TRUE (1) : Success;

FALSE (0) : Fail (Initial error, or call by pointer error, or hardware problem)

BOOL SetDO1 (BYTE DO)

BOOL SetDO2 (BYTE DO)

Set isolated DIO output (DO)

DO ([7:0]) : Output state, pin setting by hexadecimal bitmask

1 : High;

0 : Low

Return :

TRUE (1) : Success;

FALSE (0) : Fail (Initial error, or hardware problem)

BOOL GetDIO1 (WORD *DI)**BOOL GetDIO2 (WORD *DI)**

Get non-isolated DIO input (DIO input)

DI ([15:0]) : Input state, pin setting by hexadecimal bitmask

1 : High;

0 : Low

Return :

TRUE (1) : Success;

FALSE (0) : Fail (Initial error, or call by pointer error, or hardware problem)

BOOL SetDIO1 (WORD DO)**BOOL SetDIO2 (WORD DO)**

Set non-isolated DIO output (DIO output)

DO ([15:0]) : output state, pin setting by hexadecimal bitmask

1 : High;

0 : Low

Return :

TRUE (1) : Success;

FALSE (0) : Fail (Initial error, or hardware problem)

BOOL GetWDT (DWORD *WDT)

Get watchdog timer setup

WDT : watchdog timer setup

Unit : second. (Range : 0 ~ 65535 sec, 1093 ~ 65535 min (=65580 ~ 3932100 sec))

Return :

TRUE (1) : Success;

FALSE (0) : Fail (Initial error, or call by pointer error, or hardware problem)

BOOL SetWDT (DWORD WDT)

Set watchdog timer setup

WDT : watchdog timer setup

Unit : second. (Range : 1 ~ 65535 sec, 1093 ~ 65535 min (=65580 ~ 3932100 sec))

Return :

TRUE (1) : Success;

FALSE (0) : Fail (Initial error, or setup 0 error, or hardware problem)

BOOL CancelWDT ()

Cancel watchdog timer

Return :

TRUE (1) : Success;

FALSE (0) : Fail (Initial error, or hardware problem)

C

APPENDIX C : RAID Functions

C.1.1 SATA Mode for RAID

Please select SATA Device to RAID mode on BIOS menu.

Advanced → SATA Configuration → SATA Mode Selection → RAID (Skylake platform)/Intel RST Premium (Kaby Lake/Coffee Lake platform)

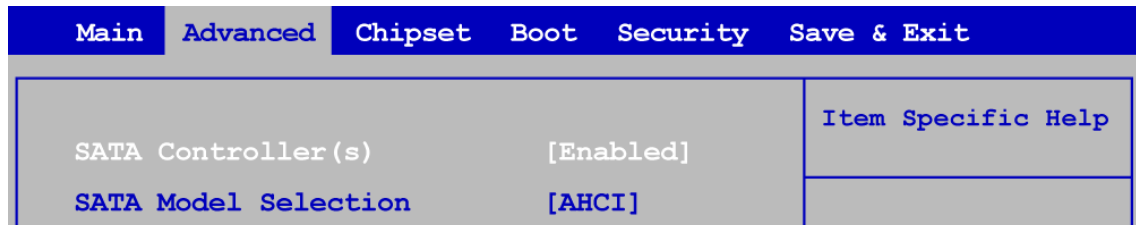

C.1.2 UEFI Mode for RAID

1. Please select SATA device to RAID mode on BIOS menu.

Advanced → SATA Configuration → SATA Mode Selection → RAID (Skylake platform)/Intel RST Premium (Kaby Lake/Coffee Lake platform)

2. Please select Software Feature Mask Configuration on BIOS menu.

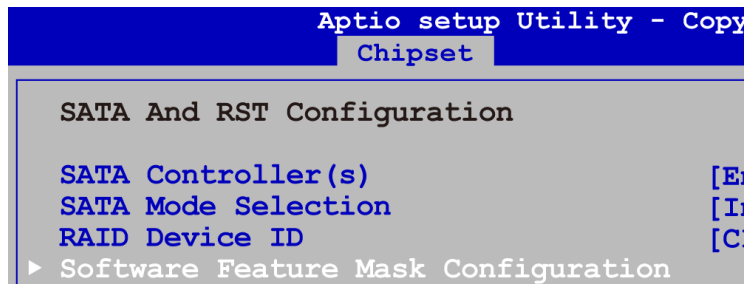

3. Use RST Legacy OROM → Disabled → Save Changes and Reset.

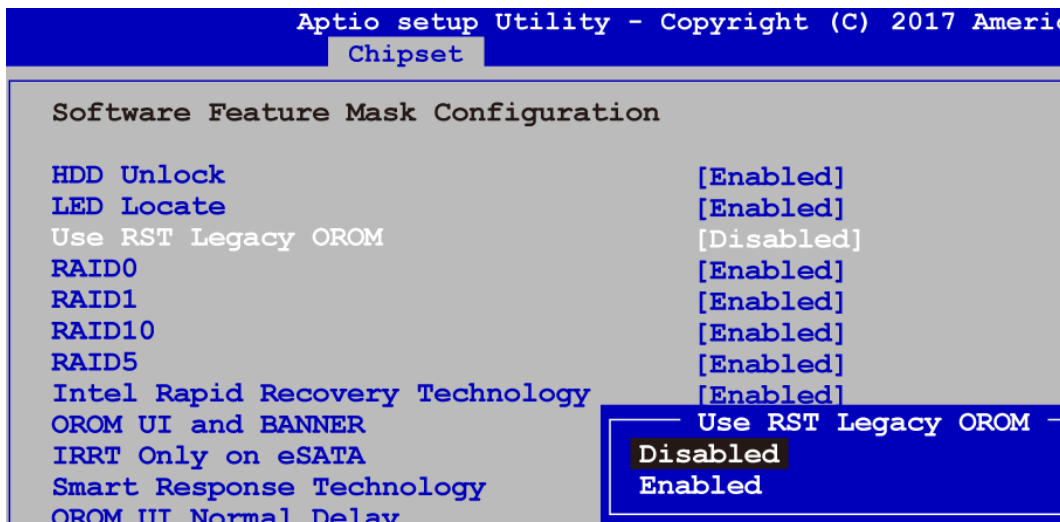

4. Into BIOS menu again, select Intel(R) Rapid Storage Technology on BIOS menu.

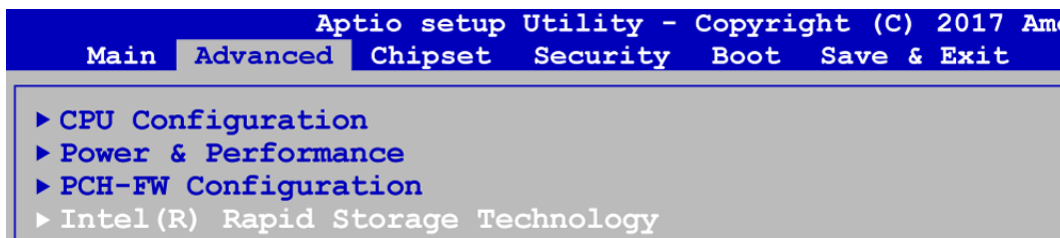

5. Select Create RAID Volume on BIOS menu.

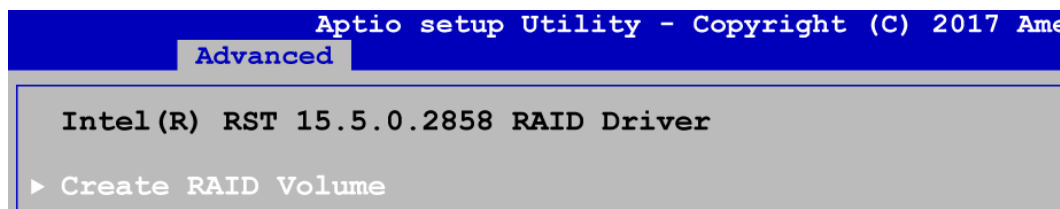

6. Select disks to create RAID Volume then Save Changes and Reset to install OS with EFI mode.

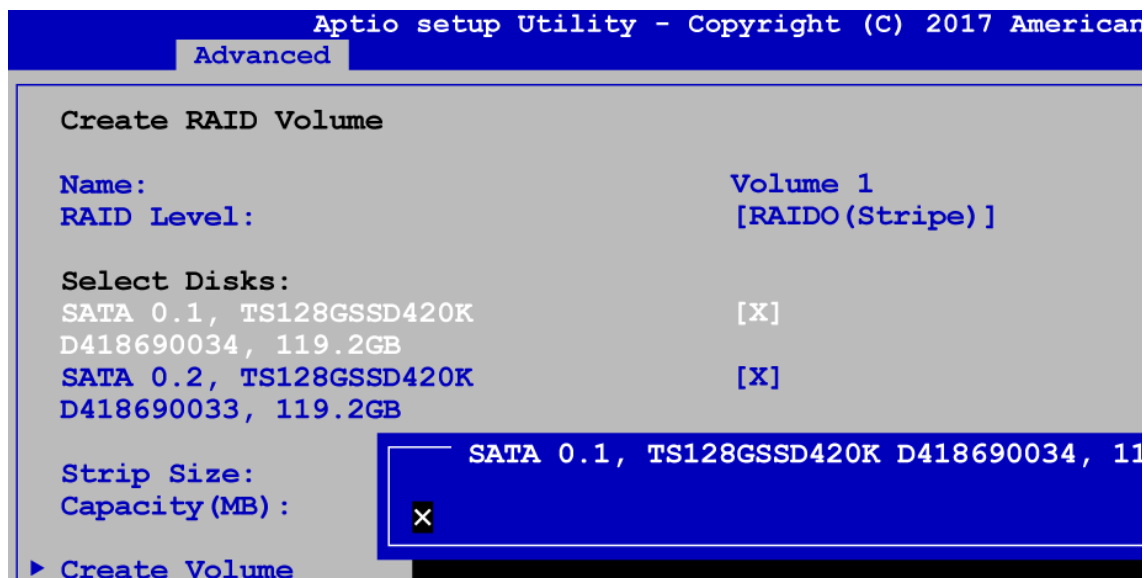

C.2 OS Installation

The system is featured with six SATA, including four internal SATA, one mSATA and one CFast.

You can select one of the SATA ports for OS installation.

We used CFast card for Windows 10 OS installation as an example.

C.3 To Install All Device Drivers of the System

The instructions are as follows :

1. Install Chipset driver
2. Install Network driver
3. Install ME driver (if available)
4. Install Audio driver
5. Install VGA driver

C.4 To Install "Intel Rapid Storage Technology" Software

You can get the software from driver CD.

Also, you can find the latest information and software directly from Intel's website.
http://www.intel.com/p/en_US/support/highlights/chpsts/imsm

The RAID environment has been done if you completed the steps above.

C.5 To Insert SATA HDD for RAID 1

Please note, you can use four SATA ports for SATA HDD, except for the CFast port and mSATA slot.

C.6 To Create RAID Volume on "Rapid Storage Technology" Software

The system is featured with six SATA HDD's for RAID volume, so there are three options to choose from on this page. Let's take RAID 1 as an example, select "RAID 1".



C.7 Disk Management : Partition the Disk

After RAID 1 volume is created, you can see the figure of SATA device allocation.

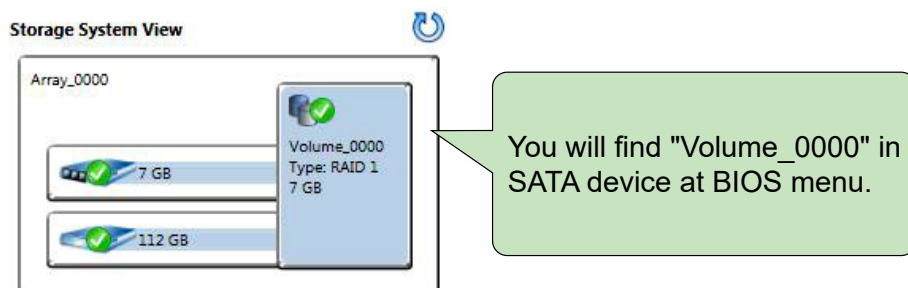

To start disk management tool, select "initialize disk".

Then add "Logical Device" for Windows access.

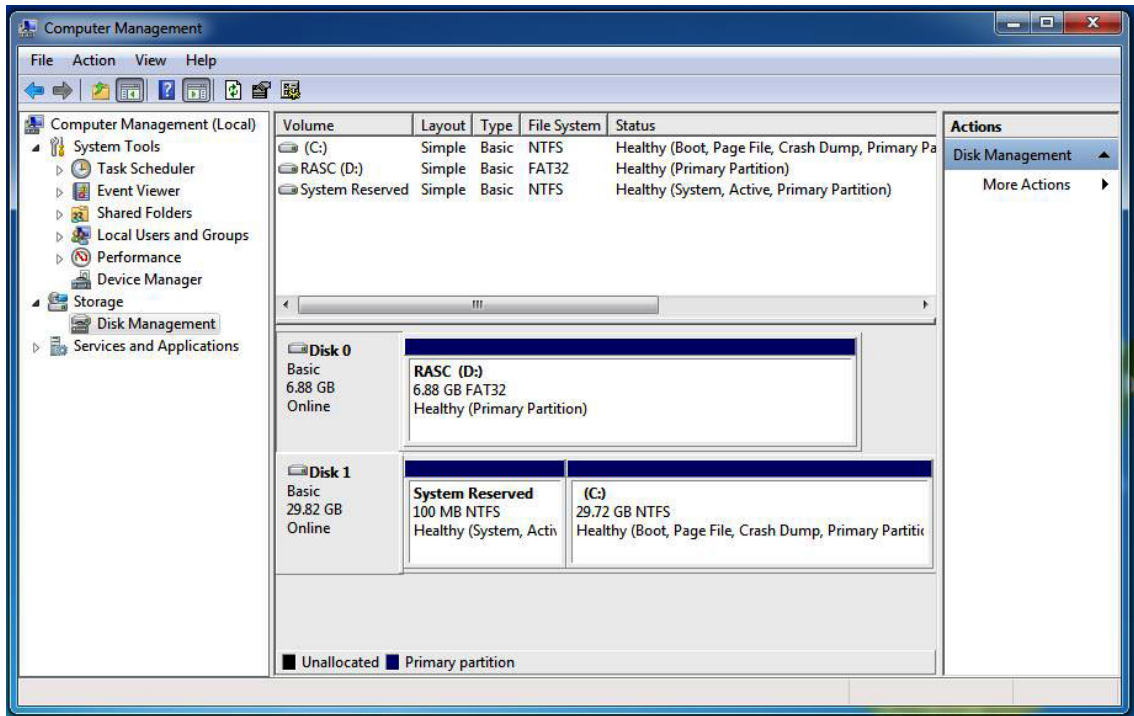

C.8 If One SATA HDD on RAID Volume is Out-of-use

After RAID 1 volume is created, you can see the figure of SATA device allocation.

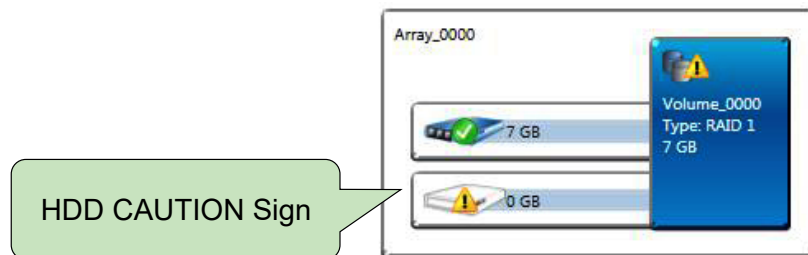

C.9 Recovery and Auto Re-build When Use the SAME RAID HDD



C.10 Recovery and Auto Re-build When Use DIFFERENT RAID HDD

There is a warning that will pop up to ask you if the disk is not a member of original RAID volume.

If you press "Rebuild", it will replace the broken SATA HDD to the last one SATA HDD of RAID volume.

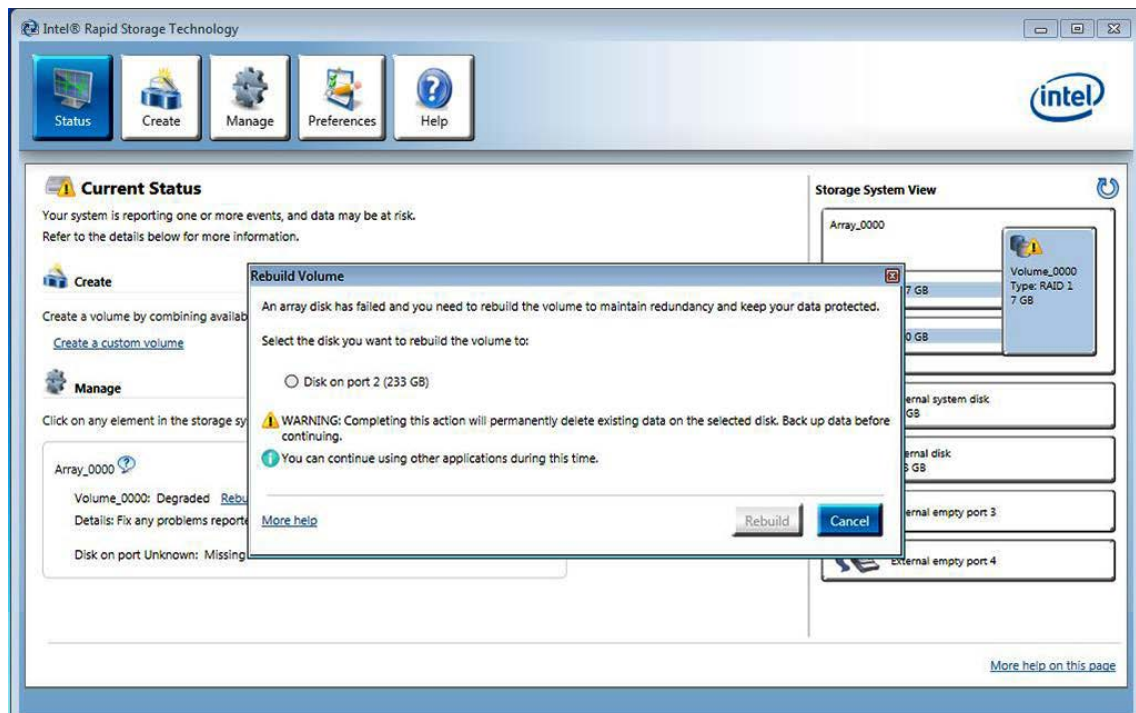

D

APPENDIX D : Power Consumption

Testing Board	RCX-1000
RAM	16GB * 2
USB-1	USB Microsoft Wired Keyboard 600
USB-2	USB Mouse HP G1K28AA
USB-3	USB Flash Transcend 3.0 8GB
USB-4	USB Flash Transcend 3.0 8GB
USB-5	USB Flash Kingston 3.0 16GB
USB-6	USB Flash Kingston 3.0 32GB
SATA 0	Transcend SATA SSD420 128GB
SATA 1	Seagate HDD 500GB
LAN1 (i219)	1.0 Gbps
LAN2 (i210)	1.0 Gbps
Graphics output	DVI
Power plan	Balance(Windows10 Power plan)
Power Source	Chroma 62006P-100-25
Test Program-1	BurnInTest
Test Program-2	FurMark

D.1 Intel® Core™ i7-8700T (8M Cache, 2.4 GHz)

CPU	Power Input	Standby Mode	
		Max Current	Max Consumption
Core™ i7-8700T	9V	0.437A	3.93W
Core™ i7-8700T	12V	0.330A	3.96W
Core™ i7-8700T	24V	0.271A	6.50W
Core™ i7-8700T	36V	0.266A	9.59W

CPU	Power Input	Power on and boot to Win10 64bit			
		Sleep Mode		idle status CPU usage less 3%	
		Max Current	Max Consumption	Max Current	Max Consumption
Core™ i7-8700T	9V	0.578A	5.20W	1.673A	15.06W
Core™ i7-8700T	12V	0.434A	5.21W	1.249A	14.98W
Core™ i7-8700T	24V	0.320A	7.69W	0.830A	19.92W
Core™ i7-8700T	36V	0.300A	10.81W	0.589A	21.19W

CPU	Power Input	Power on and boot to Win10 64-bit			
		Run 100% CPU usage without 2D		Run 100% CPU usage without 3D	
		Max Current	Max Consumption	Max Current	Max Consumption
Core™ i7-8700T	9V	4.720A	42.48W	5.880A	52.92W
Core™ i7-8700T	12V	3.394A	40.73W	3.949A	47.39W
Core™ i7-8700T	24V	1.898A	45.54W	2.282A	54.76W
Core™ i7-8700T	36V	1.251A	45.03W	1.898A	68.32W

D.2 Intel® Core™ i7-8700 (12M Cache, 3.2 GHz)

CPU	Power Input	Standby Mode	
		Max Current	Max Consumption
Core™ i7-8700	9V	0.480A	4.32W
Core™ i7-8700	12V	0.323A	3.87W
Core™ i7-8700	24V	0.265A	6.35W
Core™ i7-8700	36V	0.260A	9.37W

CPU	Power Input	Power on and boot to Win10 64bit			
		Sleep Mode		idle status CPU usage less 3%	
		Max Current	Max Consumption	Max Current	Max Consumption
Core™ i7-8700	9V	0.586A	5.27W	1.809A	16.28W
Core™ i7-8700	12V	0.429A	5.15W	1.395A	16.73W
Core™ i7-8700	24V	0.316A	7.59W	0.862A	20.69W
Core™ i7-8700	36V	0.295A	10.62W	0.647A	23.30W

CPU	Power Input	Power on and boot to Win10 64-bit			
		Run 100% CPU usage without 2D		Run 100% CPU usage without 3D	
		Max Current	Max Consumption	Max Current	Max Consumption
Core™ i7-8700	9V	6.453A	58.08W	8.803A	79.23W
Core™ i7-8700	12V	4.686A	56.23W	5.904A	70.85W
Core™ i7-8700	24V	2.587A	62.08W	3.092A	74.20W
Core™ i7-8700	36V	1.764A	63.51W	2.055A	73.98W

D.3 Intel® Xeon® E-2176G (12M Cache, up to 4.7 GHz)

CPU	Power Input	Standby Mode	
		Max Current	Max Consumption
Xeon® E-2176G	9V	0.434A	3.91W
Xeon® E-2176G	12V	0.329A	3.95W
Xeon® E-2176G	24V	0.269A	6.45W
Xeon® E-2176G	36V	0.264A	9.51W

CPU	Power Input	Power on and boot to Win10 64bit			
		Sleep Mode		idle status CPU usage less 3%	
		Max Current	Max Consumption	Max Current	Max Consumption
Xeon® E-2176G	9V	0.571A	5.14W	1.893A	17.04W
Xeon® E-2176G	12V	0.433A	5.19W	1.323A	15.88W
Xeon® E-2176G	24V	0.322A	7.73W	0.866A	20.78W
Xeon® E-2176G	36V	0.301A	10.82W	0.858A	30.90W

CPU	Power Input	Power on and boot to Win10 64-bit			
		Run 100% CPU usage without 2D		Run 100% CPU usage without 3D	
		Max Current	Max Consumption	Max Current	Max Consumption
Xeon® E-2176G	9V	8.490A	76.41W	10.409A	93.68W
Xeon® E-2176G	12V	6.471A	77.65W	7.392A	88.71W
Xeon® E-2176G	24V	3.344A	80.25W	4.209A	101.03W
Xeon® E-2176G	36V	2.358A	84.88W	3.043A	109.56W

D.4 Intel® Core™ i7-8700 Add RTX-2080 Graphics Card

CPU	Power Input	Standby Mode	
		Max Current	Max Consumption
Core™ i7-8700	24V	0.267A	6.40W
Core™ i7-8700	36V	0.264A	9.52W

CPU	Power Input	Power on and boot to Win10 64bit			
		Sleep Mode		idle status CPU usage less 3%	
		Max Current	Max Consumption	Max Current	Max Consumption
Core™ i7-8700	24V	0.318A	7.62W	1.994A	47.85W
Core™ i7-8700	36V	0.297A	10.71W	1.356A	48.83W

CPU	Power Input	Power on and boot to Win10 64-bit			
		Run 100% CPU usage without 2D		Run 100% CPU usage without 3D	
		Max Current	Max Consumption	Max Current	Max Consumption
Core™ i7-8700	24V	3.559A	85.40W	13.219A	317.26W
Core™ i7-8700	36V	2.452A	88.27W	9.033A	325.19W

E

APPENDIX E : Supported Memory & Storage List

E.1 Supported Memory List

Testing Board	RCX-1000
Memory Test	version : 5.1
BurnInTest	V8.1

E.2 Tset Item

Channel	Memtest	Bunin	Flash BIOS	Remove Battery
*2 (Socket 1; Socket 2)	PASS	PASS	PASS	PASS
*2 (Socket 3; Socket 4)	PASS	PASS	PASS	PASS
*1 (Socket 1)	N/A	N/A	N/A	N/A
*1 (Socket 2)	PASS	PASS	N/A	PASS
*1 (Socket 3)	N/A	N/A	N/A	N/A
*1 (Socket 4)	PASS	PASS	N/A	PASS

E.3 Supported Non-ECC Memory List

Brand	Info	Test Temp. (Celsius)
Innodisk 16G DDR4 2400 SO-DIMM	M4S0-AGS1OCSJ-H03	25°C
		25°C
Innodisk 4G DDR4 2400 SO-DIMM	M4S0-4GSSN5SJ-H03	25°C
		25°C
Innodisk 16G DDR4 2666 SO-DIMM	M4S0-AGS1O5IK-H03	25°C
		25°C
Innodisk 16G DDR4 2666 SO-DIMM	M4S0-AGS1OCIK-H03	25°C
		25°C
Innodisk 8G DDR4 2666 SO-DIMM	M4S0-8GS1N5IK-H03	25°C
		25°C
Innodisk 8G DDR4 2666 SO-DIMM	M4S0-8GSSOCIK-H03	25°C
		25°C
Innodisk 4G DDR4 2666 SO-DIMM	M4S0-4GSSN5IK-H03	25°C
		25°C
Innodisk 4G DDR4 2666 SO-DIMM	M4S0-4GSSNCIK-H03	25°C
		25°C
SLINK 8GB DDR4-2666 SO-DIMM	J48GSH1G8QHEC	25°C
		25°C
SLINK 16GB DDR4-2666 SO-DIMM	J4AGSH1G8QHFC	25°C
		25°C
SLINK 32GB DDR4-2666 SO-DIMM	J4BGSS2G8QHXC	25°C
		25°C
SLINK 32GB DDR4-2666 SO-DIMM	J4BGSS2G8QHXI	25°C
		25°C
Kingston 4GB DDR4-2666 SO-DIMM	KVR26S19S6/4	25°C
		25°C
Kingston 8GB DDR4-2666 SO-DIMM	KVR26S19S8/8	25°C
		25°C
Kingston 16GB DDR4-2666 SO-DIMM	KVR26S19D8/16	25°C
		25°C
ADATA 8GB DDR4-2666 SO-DIMM	AD4S266638G19-BSSC	25°C
		25°C
ADATA 16GB DDR4-2666 SO-DIMM	AD4S2666316G19-BSSC	25°C
		25°C

E.4 Supported ECC Memory List

Brand	Info	Test Temp. (Celsius)
Innodisk 4G DDR4 2400 SO-DIMM	M4D0-4GSSPCSJ-H03	25°C
		25°C
Innodisk 4G DDR4 2400 SO-DIMM	M4D0-4GSSP5IK-H03	25°C
		25°C
Innodisk 4G DDR4 2666 SO-DIMM	M4D0-4GSSPCIK-H03	25°C
		25°C
Innodisk 8G DDR4 2666 SO-DIMM	M4D0-8GS1P5IK-H03	25°C
		25°C
Innodisk 16G DDR4 2666 SO-DIMM	M4D0-AGS1Q5SJ-H03	25°C
		25°C
Innodisk 16G DDR4 2666 SO-DIMM	M4D0-AGS1Q5IK-H03	25°C
		25°C
Innodisk 16G DDR4 2666 SO-DIMM	M4D0-AGS1QCIC-H03	25°C
		25°C
SLINK 32G DDR4 2666 SO-DIMM	J4BGDS2G8QH KC	25°C
		25°C
SLINK 32G DDR4 2666 SO-DIMM	J4BGDS2G8QH KI	25°C
		25°C
SLINK 16G DDR4 2666 SO-DIMM	J4AGDH1G8QH KC	25°C
		25°C
SLINK 8G DDR4 2666 SO-DIMM	J48GDH1G8QH JC	25°C
		25°C

E.5 Supported Storage Device List

Type	Brand	Model	Capacity
mSATA	Transcend	mSATA TS64GMSA370	64GB
	Intel	Intel-310 SSDMAEMC080G2	80GB
	Innodisk	DEMSR-32GD06SW2QC	32GB
SATA SSD	Intel	SSD E5400s SSDSC2KR120H6	120GB
		SSD 540s SSDSC2KW120H6	120GB
	Innodisk	3MG2-P DGS25-64GD81BC1QC	64GB
	MEMXPRO	M3A MI3MA1212802WN	128GB
	LITE-ON	K8-L1512	512GB
		K8-L1256	256GB
	Transcend	TS128GSSD420K	128GB
		SSD370 TS64GSSD370I	64GB
	Kingston	SUV400S37	120GB
	FORESEE	S903S128G	128GB
		S903S256G	256GB
	ADATA	ISSS332-128GM	128GB
		ISSS332-256GM	256GB
M.2 SSD (PCIe)	ADATA	IM2P33F8-128GD	128GB
		IM2P33F8-256GD	256GB
	Toshiba	KXG50ZNV512G	512GB
	Phison	ESMP256GTB3C2-E12	256GB
	FORESEE	FSGMMC-256G	256GB

** If more help is needed, please contact Vecow Technical Support.

F

APPENDIX F : How to Install Power Supply

F.1.1 HEP-600-24 Adapter AC Cable

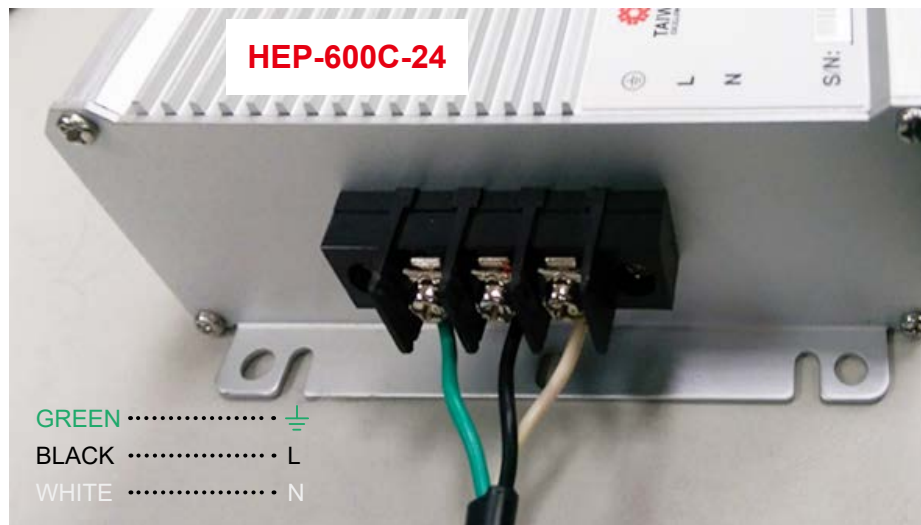

F.1.2 HEP-600-24 Adapter DC Cable

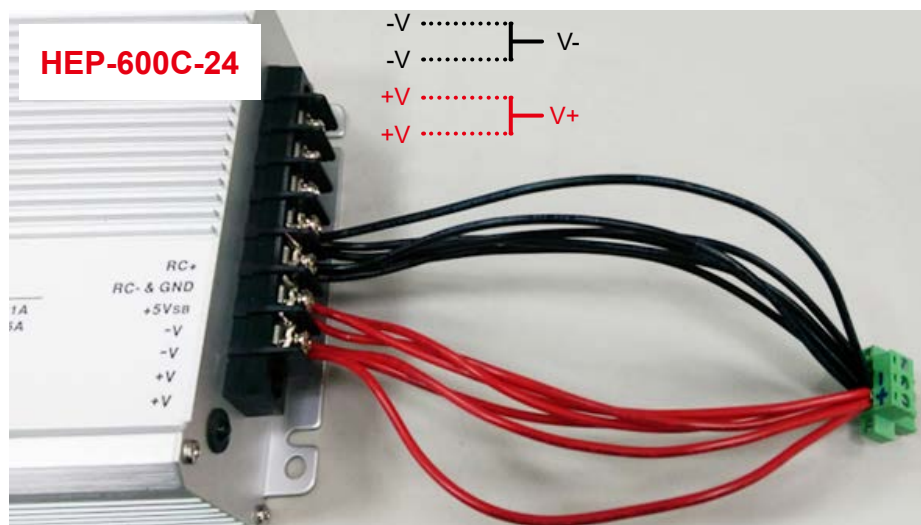

F.2.1 PWS-600W Adapter AC Cable



Adapter (PWS-600W) Input	AC Power Cord
L	BLACK
N	WHITE
⏏	GREEN

F.2.2 PWS-600W Adapter DC Cable

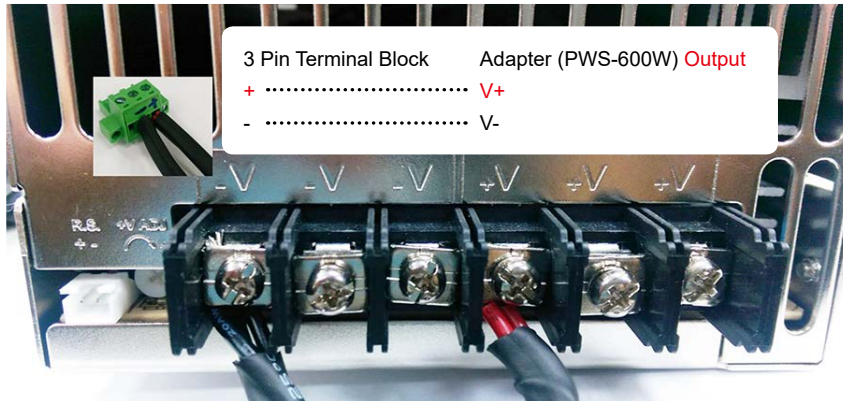

3 Pin Terminal Block	Adapter (PWS-600W) Output
+	V+
-	V-

F.3.1 PWS-480W Adapter AC Cable

Adapter (PWS-480W-WT) Input	AC Power Cord
BROWN	BLACK
GREEN/YELLOW	GREEN
BLUE	WHITE



F.3.2 PWS-480W Adapter DC Cable

3 Pin Terminal Block	Adapter (PWS-480W-WT) Output
+	BROWNx2
-	BLUEx2



F.4.1 PWS-360W Adapter AC Cable

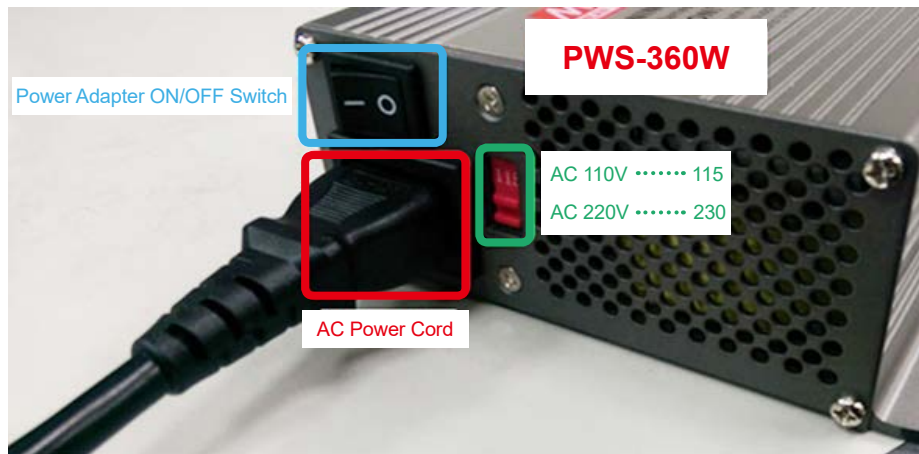

F.4.2 PWS-360W Adapter AC Cable

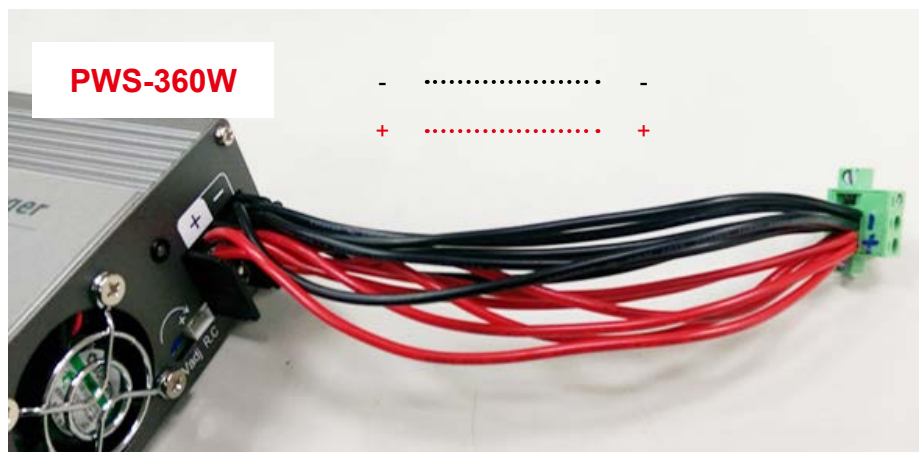

F.5.1 RSP-1500-12 Adapter AC Cable

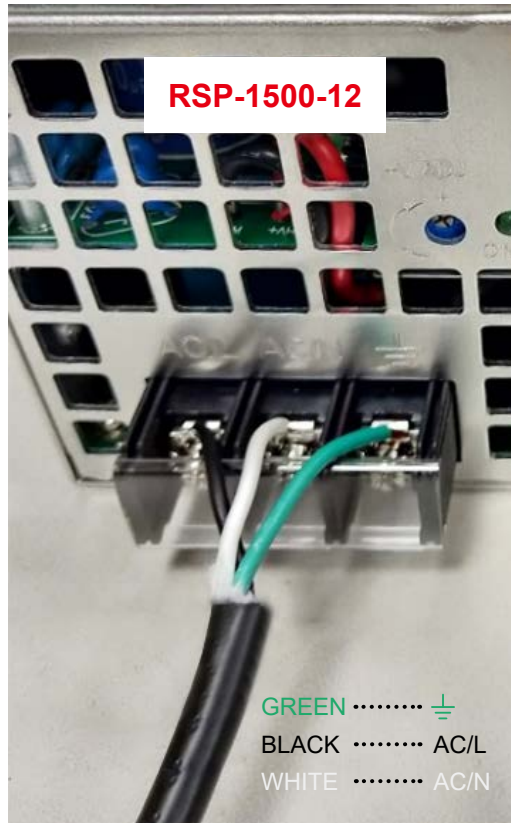

F.5.2 RSP-1500-12 Adapter DC Cable

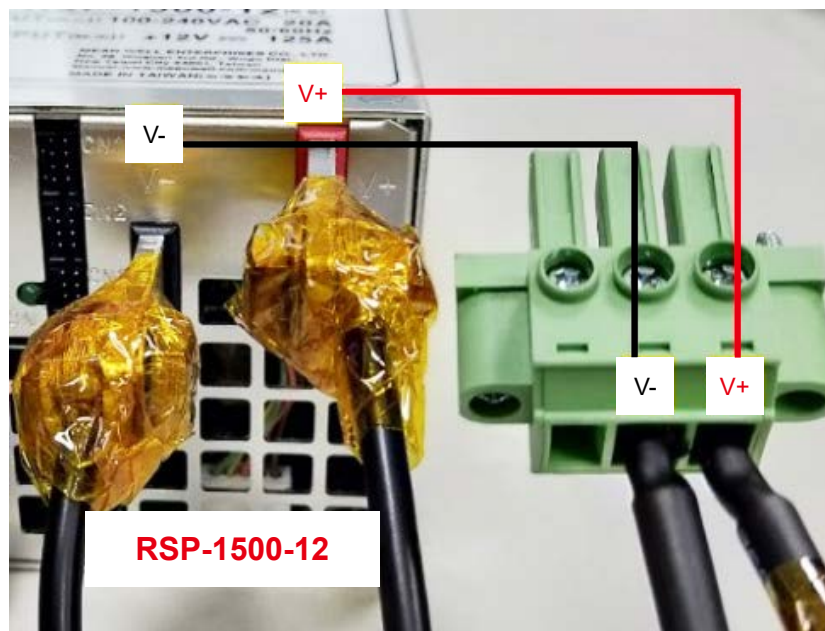



APPENDIX G : Install Win11 (BIOS TPM Setting)

Step 1 Click on “Advanced”, then click on “PCH-FW Configuration”

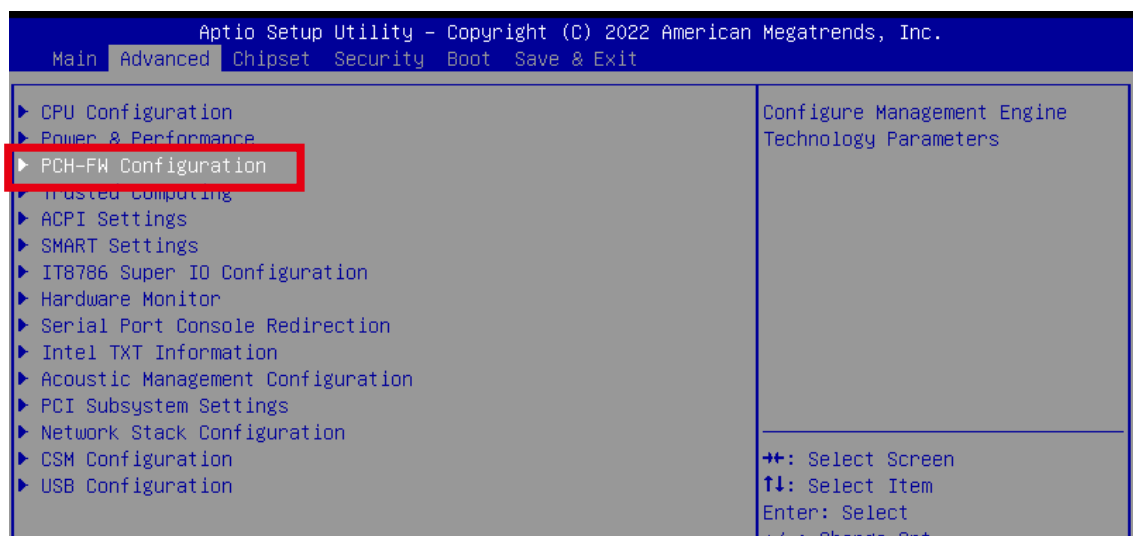

Step 2 Click on “PTT Configuration”

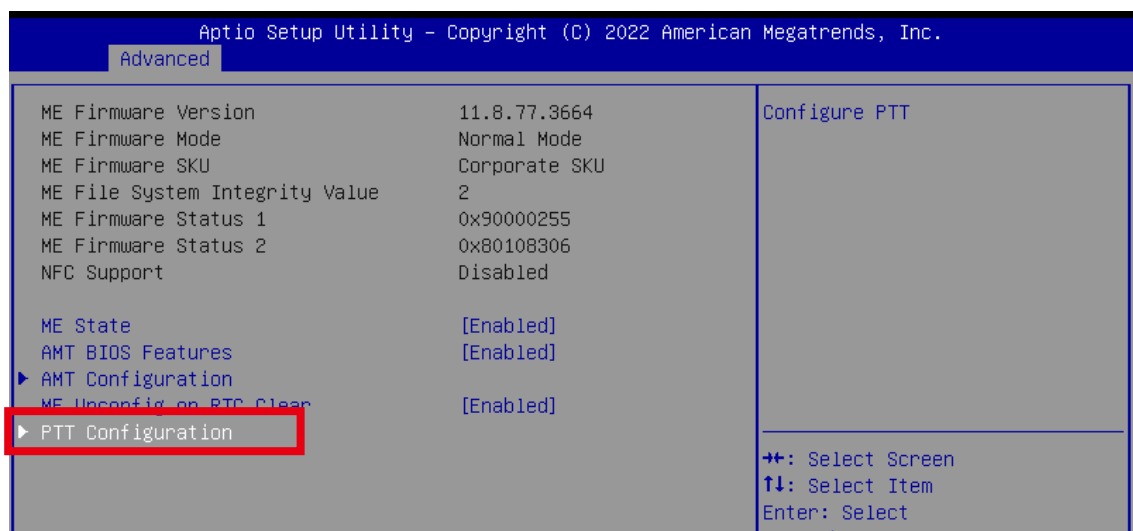

Step 3 Click on “dTPM” (TPM Device Selection)

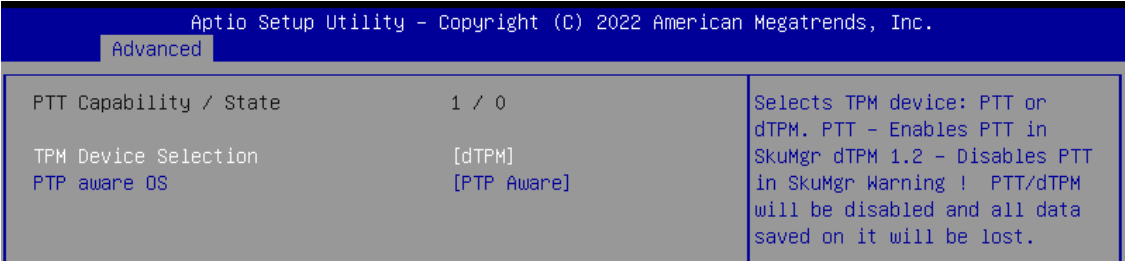
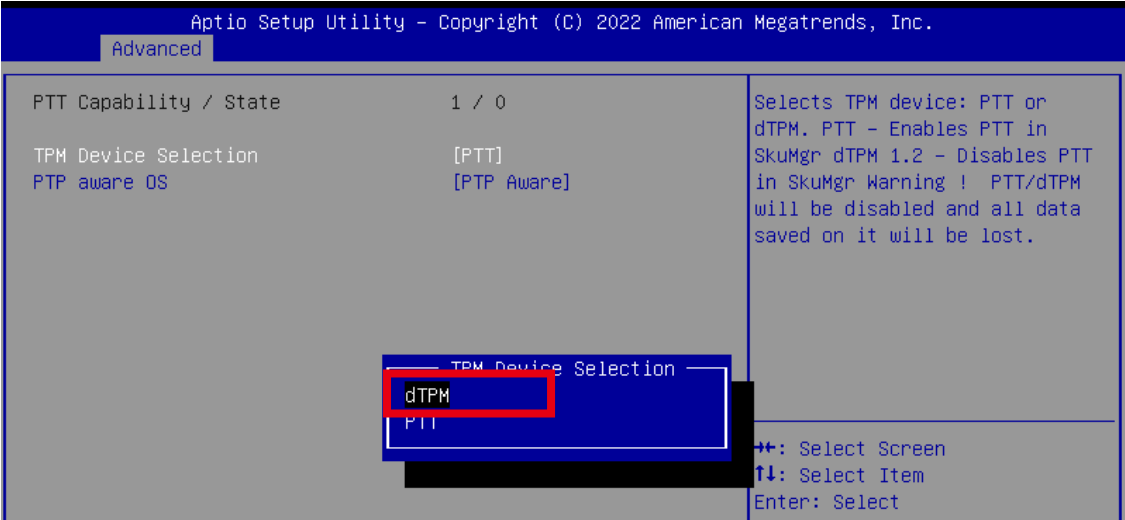

Step 4 Please save the BIOS settings by pressing F4. Please press Enter when the pop-up window which asks “Save configuration and exit?” appears. The computer will then restart.

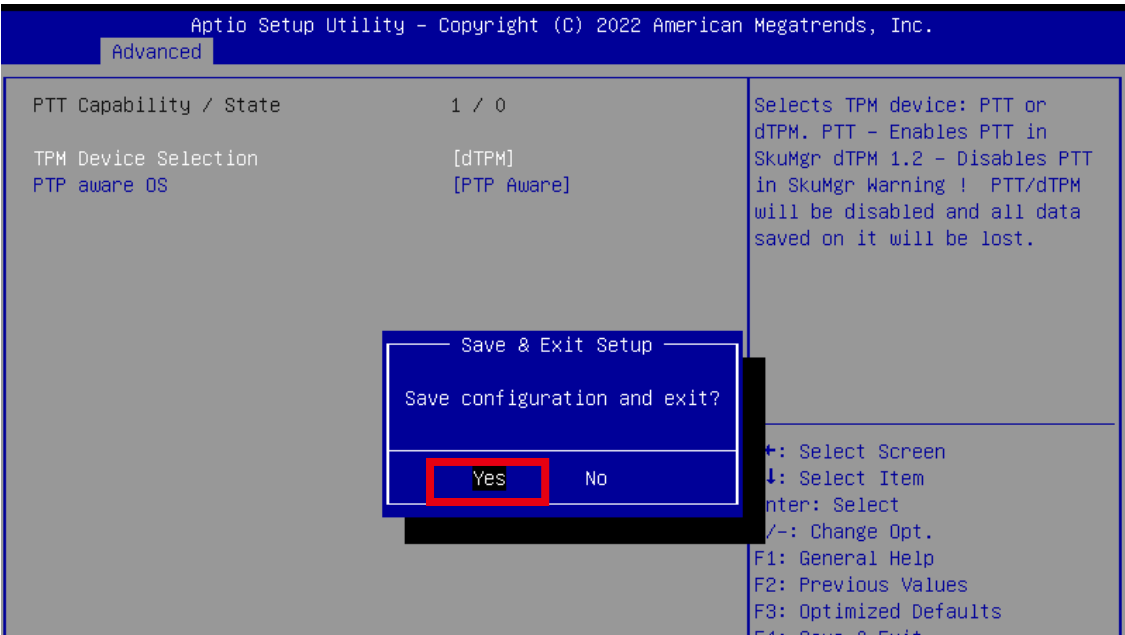

Step 5 Click on “Trusted Computing”

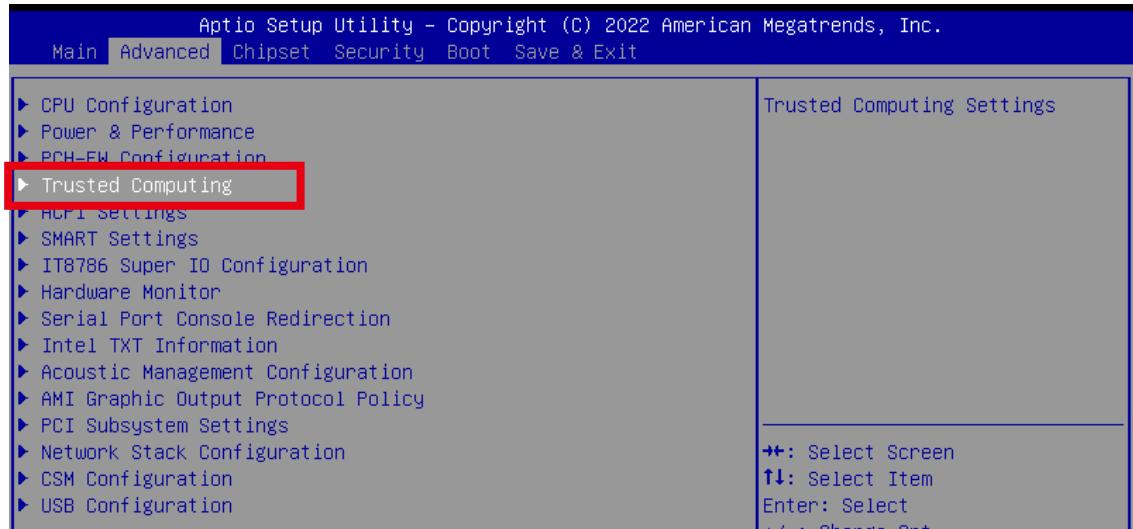

Step 6 If the window shows “TPM2.0 Device Found Firmware Version:5.62”, then the setting is completed.

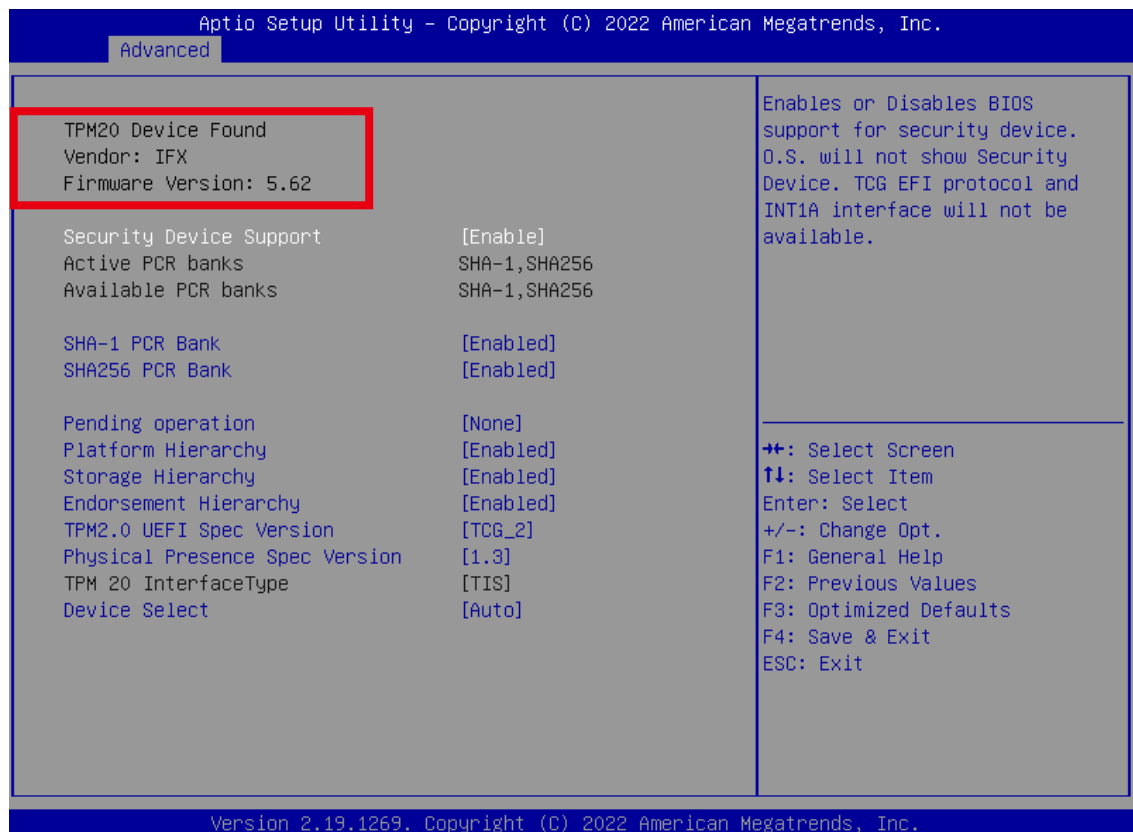

** If more help is needed, please contact Vecow technical support **



For further support information, please visit www.vecow.com

This document is released for reference purpose only.

All product offerings and specifications are subject to change without prior notice.

No part of this publication may be reproduced in any form or by any means, electric, photocopying, or recording, without prior authorization from the publisher.

The rights of all the brand names, product names, and trademarks belong to their respective owners.

© Vecow Co., Ltd. 2023. All rights reserved.